

TransPocket 2500 Comfort **TransPocket 3500 Comfort**

EN

Operating instructions

Rod electrode power source

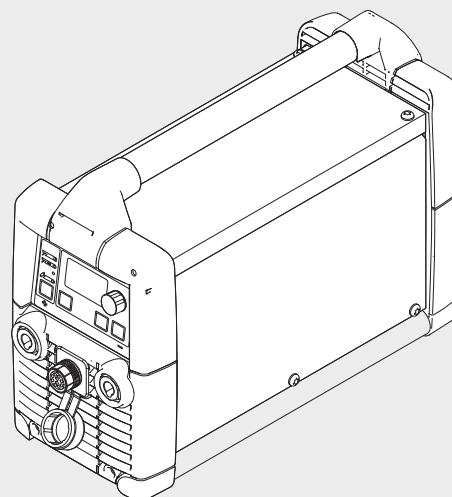

42,0426,0065,EN 014-23122020

Contents

Safety rules.....	6
Explanation of safety notices.....	6
General.....	6
Proper use.....	6
Environmental conditions.....	7
Obligations of the operator.....	7
Obligations of personnel.....	7
Mains connection.....	7
Residual current protective device.....	8
Protecting yourself and others.....	8
Noise emission values.....	8
Danger from toxic gases and vapours.....	9
Danger from flying sparks.....	9
Risks from mains current and welding current.....	10
Meandering welding currents.....	11
EMC Device Classifications.....	11
EMC measures.....	11
EMF measures.....	12
Specific hazards.....	12
Requirement for the shielding gas.....	13
Danger from shielding gas cylinders.....	13
Safety measures at the installation location and during transport.....	14
Safety measures in normal operation.....	14
Commissioning, maintenance and repair.....	15
Safety inspection.....	15
Disposal.....	15
Safety symbols.....	16
Data protection.....	16
Copyright.....	16
General.....	17
Principle.....	17
Device concept.....	17
Application areas.....	17
Control elements and connections.....	18
Safety.....	18
Controls.....	18
Connections.....	19
Before commissioning.....	20
Safety.....	20
Proper use.....	20
Setup regulations.....	20
Mains connection.....	20
Changing mains voltage (only MVm versions).....	22
General remarks.....	22
Mains voltage tolerance range.....	22
Changing mains voltage.....	22
Single-phase operation.....	23
MMA welding.....	24
Safety.....	24
Welding parameters: Display and navigation.....	24
Welding parameters.....	25
Preparations.....	26
MMA welding.....	26
HotStart function (used with rutile and Cel processes).....	28
SoftStart function (used with basic process).....	28
Anti-stick function.....	28
Remote control mode.....	28
TIG welding.....	30
Safety.....	30
Welding parameters and navigation.....	30

Welding parameters	30
Requirement	31
Preparations	31
Setting the shielding gas flow rate for a gas-valve torch	32
Setting the shielding gas flow rate for the TTG 2200 TCS torch	32
TIG welding	34
Adjusting welding current, igniting the arc	34
Remote control mode	35
TIG Comfort Stop function	35
Welding job	38
Safety	38
Preparations	38
Job welding	38
Saving settings as a job	40
General remarks	40
Storing settings as a job	40
The Setup menu	43
General remarks	43
Opening a Setup menu	43
Selecting and setting parameters	43
Exiting a Setup menu	44
Overview	44
Easy Mode	45
General remarks	45
Activating Easy Mode	45
Selecting the welding process in Easy Mode	46
Deactivating Easy Mode	48
MMA setup	50
MMA setup	50
MMA setup parameters	50
CEL electrode setup (Cel-elec.-Setup)	51
CEL setup	51
Cel setup parameters	51
Job setup	53
Job setup	53
Opening the job setup for a saved job	53
Copying a job	54
Job setup parameters for MMA and CEL jobs	57
Job setup parameters for TIG jobs	59
TIG setup	60
TIG setup	60
TIG setup parameters	60
The Service menu	61
General remarks	61
Opening the Service menu	61
Selecting and setting parameters	61
Exiting the Service menu	62
Parameters in the Service menu	62
Setting the language	64
Resetting the power source factory settings	65
Opening the Info screen	66
Voltage Reduction Device (VRD versions only)	68
General	68
Safety principle	68
VRD display	68
Troubleshooting	70
Safety	70
Fault diagnosis	70
Service codes	73
Care, maintenance and disposal	76
General	76
At every start-up	76
Every 2 months	76
Every 6 months	76

Disposal.....	76
Average consumption values during welding	77
Average wire electrode consumption during MIG/MAG welding	77
Average shielding gas consumption during MIG/MAG welding.....	77
Average shielding gas consumption during TIG welding.....	77
Technical data.....	78
Safety.....	78
Generator-powered operation.....	78
TP 2500 Comfort.....	78
TP 2500 Comfort MVm.....	79
TP 3500 Comfort.....	80
TP 3500 Comfort MVm	81
Overview with critical raw materials, year of production of the device.....	82

Safety rules

Explanation of safety notices

DANGER!

Indicates **immediate danger**.

- ▶ If not avoided, death or serious injury will result.
-

WARNING!

Indicates a **potentially hazardous situation**.

- ▶ If not avoided, death or serious injury may result.
-

CAUTION!

Indicates a **situation where damage or injury could occur**.

- ▶ If not avoided, minor injury and/or damage to property may result.
-

NOTE!

Indicates a **risk of flawed results and possible damage to the equipment**.

General

The device is manufactured using state-of-the-art technology and according to recognised safety standards. If used incorrectly or misused, however, it can cause:

- injury or death to the operator or a third party,
 - damage to the device and other material assets belonging to the operating company,
 - inefficient operation of the device.
-

All persons involved in commissioning, operating, maintaining and servicing the device must:

- be suitably qualified,
 - have sufficient knowledge of welding and
 - read and follow these operating instructions carefully.
-

The operating instructions must always be at hand wherever the device is being used. In addition to the operating instructions, attention must also be paid to any generally applicable and local regulations regarding accident prevention and environmental protection.

All safety and danger notices on the device

- must be in a legible state,
 - must not be damaged,
 - must not be removed,
 - must not be covered, pasted or painted over.
-

For the location of the safety and danger notices on the device, refer to the section headed "General" in the operating instructions for the device.

Before switching on the device, rectify any faults that could compromise safety.

This is for your personal safety!

Proper use

The device is to be used exclusively for its intended purpose.

The device is intended solely for the welding processes specified on the rating plate. Any use above and beyond this purpose is deemed improper. The manufacturer shall not be held liable for any damage arising from such usage.

Proper use includes:

- carefully reading and following all the instructions given in the operating instructions
- studying and obeying all safety and danger notices carefully
- performing all stipulated inspection and maintenance work.

Never use the device for the following purposes:

- Thawing out pipes
- Charging batteries
- Starting engines

The device is designed for use in industry and the workshop. The manufacturer accepts no responsibility for any damage caused through use in a domestic setting.

The manufacturer likewise accepts no liability for inadequate or incorrect results.

Environmental conditions

Operation or storage of the device outside the stipulated area will be deemed as not in accordance with the intended purpose. The manufacturer shall not be held liable for any damage arising from such usage.

Ambient temperature range:

- during operation: -10 °C to + 40 °C (14 °F to 104 °F)
- during transport and storage: -20 °C to +55 °C (-4 °F to 131 °F)

Relative humidity:

- up to 50% at 40 °C (104 °F)
- up to 90% at 20 °C (68 °F)

The surrounding air must be free from dust, acids, corrosive gases or substances, etc. Can be used at altitudes of up to 2000 m (6561 ft. 8.16 in.)

Obligations of the operator

The operator must only allow persons to work with the device who:

- are familiar with the fundamental instructions regarding safety at work and accident prevention and have been instructed in how to use the device
- have read and understood these operating instructions, especially the section "safety rules", and have confirmed as much with their signatures
- are trained to produce the required results.

Checks must be carried out at regular intervals to ensure that operators are working in a safety-conscious manner.

Obligations of personnel

Before using the device, all persons instructed to do so undertake:

- to observe the basic instructions regarding safety at work and accident prevention
- to read these operating instructions, especially the "Safety rules" section and sign to confirm that they have understood them and will follow them.

Before leaving the workplace, ensure that people or property cannot come to any harm in your absence.

Mains connection

Devices with a higher rating may affect the energy quality of the mains due to their current consumption.

This may affect a number device types in terms of:

- Connection restrictions
- Criteria with regard to the maximum permissible mains impedance ^{*)}
- Criteria with regard to the minimum short-circuit power requirement ^{*)}

^{*)} at the interface with the public grid
see "Technical data"

In this case, the plant operator or the person using the device should check whether the device may be connected, where appropriate by discussing the matter with the power supply company.

IMPORTANT! Ensure that the mains connection is earthed properly

Residual current protective device

Local regulations and national guidelines may require a residual current protective device when connecting equipment to the public grid.

The type of residual current protective device recommended by the manufacturer for the equipment is indicated in the technical data.

Protecting yourself and others

Anyone working with the device exposes themselves to numerous risks, e.g.

- flying sparks and hot pieces of metal
 - Arc radiation, which can damage eyes and skin
 - Hazardous electromagnetic fields, which can endanger the lives of those using cardiac pacemakers
 - Risk of electrocution from mains current and welding current
 - Greater noise pollution
 - Harmful welding fumes and gases
-

Suitable protective clothing must be worn when working with the device. The protective clothing must have the following properties:

- Flame-resistant
 - Insulating and dry
 - Covers the whole body, is undamaged and in good condition
 - Safety helmet
 - Trousers with no turn-ups
-

Protective clothing refers to a variety of different items. Operators should:

- Protect eyes and face from UV rays, heat and sparks using a protective visor and regulation filter
 - Wear regulation protective goggles with side protection behind the protective visor
 - Wear stout footwear that provides insulation even in wet conditions
 - Protect the hands with suitable gloves (electrically insulated and providing protection against heat)
 - Wear ear protection to reduce the harmful effects of noise and to prevent injury
-

Keep all persons, especially children, out of the working area while any devices are in operation or welding is in progress. If, however, there are people in the vicinity:

- Make them aware of all the dangers (risk of dazzling by the arc, injury from flying sparks, harmful welding fumes, noise, possible risks from mains current and welding current, etc.)
 - Provide suitable protective equipment
 - Alternatively, erect suitable safety screens/curtains.
-

Noise emission values

The device generates a maximum sound power level of <80 dB(A) (ref. 1pW) when idling and in the cooling phase following operation at the maximum permissible operating point under maximum rated load conditions according to EN 60974-1.

It is not possible to provide a workplace-related emission value during welding (or cutting) as this is influenced by both the process and the environment. All manner of different welding parameters come into play, including the welding process (MIG/MAG, TIG welding), the type of power selected (DC or AC), the power range, the type of weld metal, the resonance characteristics of the workpiece, the workplace environment, etc.

Danger from toxic gases and vapours

The fumes produced during welding contain harmful gases and vapours.

Welding fumes contain substances that cause cancer, as stated in Monograph 118 of the International Agency for Research on Cancer.

Use at-source extraction and a room extraction system.
If necessary, use a welding torch with an integrated extraction device.

Keep your face away from welding fumes and gases.

Fumes and hazardous gases

- must not be breathed in
- must be extracted from the working area using appropriate methods.

Ensure an adequate supply of fresh air. Ensure that there is a ventilation rate of at least 20 m³ per hour at all times.

Otherwise, a welding helmet with an air supply must be worn.

If there is any doubt about whether the extraction capacity is sufficient, the measured toxic emission values should be compared with the permissible limit values.

The following components are responsible, amongst other things, for the degree of toxicity of welding fumes:

- Metals used for the workpiece
- Electrodes
- Coatings
- Cleaners, degreasers, etc.
- Welding process used

The relevant material safety data sheets and manufacturer's specifications for the listed components should therefore be studied carefully.

Recommendations for trade fair scenarios, risk management measures and for identifying working conditions can be found on the European Welding Association website under Health & Safety (<https://european-welding.org>).

Flammable vapours (e.g. solvent fumes) should be kept away from the arc's radiation area.

Close the shielding gas cylinder valve or main gas supply if no welding is taking place.

Danger from flying sparks

Flying sparks may cause fires or explosions.

Never weld close to flammable materials.

Flammable materials must be at least 11 metres (36 ft. 1.07 in.) away from the arc, or alternatively covered with an approved cover.

A suitable, tested fire extinguisher must be available and ready for use.

Sparks and pieces of hot metal may also get into adjacent areas through small gaps or openings. Take appropriate precautions to prevent any danger of injury or fire.

Welding must not be performed in areas that are subject to fire or explosion or near sealed tanks, vessels or pipes unless these have been prepared in accordance with the relevant national and international standards.

Do not carry out welding on containers that are being or have been used to store gases, propellants, mineral oils or similar products. Residues pose an explosive hazard.

Risks from mains current and welding current

An electric shock is potentially life threatening and can be fatal.

Do not touch live parts either inside or outside the device.

During MIG/MAG welding and TIG welding, the welding wire, the wirespool, the feed rollers and all pieces of metal that are in contact with the welding wire are live.

Always set the wirefeeder up on a sufficiently insulated surface or use a suitable, insulated wirefeeder holder.

Make sure that you and others are protected with an adequately insulated, dry temporary backing or cover for the earth or ground potential. This temporary backing or cover must extend over the entire area between the body and the earth or ground potential.

All cables and leads must be secured, undamaged, insulated and adequately dimensioned. Replace loose connections and scorched, damaged or inadequately dimensioned cables and leads immediately.

Use the handle to ensure the power connections are tight before every use.

In the case of power cables with a bayonet connector, rotate the power cable around the longitudinal axis by at least 180° and pre-load.

Do not wrap cables or leads around the body or parts of the body.

The electrode (rod electrode, tungsten electrode, welding wire, etc.) must

- never be immersed in liquid for cooling
 - Never touch the electrode when the power source is switched on.
-

Double the open circuit voltage of a power source can occur between the welding electrodes of two power sources. Touching the potentials of both electrodes at the same time may be fatal under certain circumstances.

Arrange for the mains cable to be checked regularly by a qualified electrician to ensure the ground conductor is functioning properly.

The device must only be operated on a mains supply with a ground conductor and a socket with a ground conductor contact.

Operating the device on a grid without a ground conductor and in a socket without a ground conductor contact will be deemed gross negligence. The manufacturer shall not be held liable for any damage arising from such usage.

If necessary, provide an adequate earth connection for the workpiece.

Switch off unused devices.

Wear a safety harness if working at height.

Before working on the device, switch it off and pull out the mains plug.

Attach a clearly legible and easy-to-understand warning sign to the device to prevent anyone from plugging the mains plug back in and switching it on again.

After opening the device:

- Discharge all live components
 - Ensure that all components in the device are de-energised
-

If work on live parts is required, appoint a second person to switch off the main switch at the right moment.

Meandering welding currents

If the following instructions are ignored, meandering welding currents can develop with the following consequences:

- Fire hazard
- Overheating of parts connected to the workpiece
- Irreparable damage to ground conductors
- Damage to device and other electrical equipment

Ensure that the workpiece is held securely by the workpiece clamp.

Attach the workpiece clamp as close as possible to the area that is to be welded.

If the floor is electrically conductive, the device must be set up with sufficient insulating material to insulate it from the floor.

If distribution boards, twin-head mounts, etc., are being used, note the following: The electrode of the welding torch / electrode holder that is not used is also live. Make sure that the welding torch / electrode holder that is not used is kept sufficiently insulated.

In the case of automated MIG/MAG applications, ensure that only an insulated wire electrode is routed from the welding wire drum, large wirefeeder spool or wirepool to the wire-feed unit.

EMC Device Classifications

Devices in emission class A:

- Are only designed for use in industrial settings
- Can cause line-bound and radiated interference in other areas

Devices in emission class B:

- Satisfy the emissions criteria for residential and industrial areas. This is also true for residential areas in which the energy is supplied from the public low-voltage mains.

EMC device classification as per the rating plate or technical data.

EMC measures

In certain cases, even though a device complies with the standard limit values for emissions, it may affect the application area for which it was designed (e.g. when there is sensitive equipment at the same location, or if the site where the device is installed is close to either radio or television receivers).

If this is the case, then the operator is obliged to take appropriate action to rectify the situation.

Check and evaluate the immunity to interference of nearby devices according to national and international regulations. Examples of equipment that may be susceptible to interference from the device include:

- Safety devices
- Power, signal and data transfer lines
- IT and telecommunications devices
- Measuring and calibrating devices

Supporting measures for avoidance of EMC problems:

1. Mains supply
 - If electromagnetic interference arises despite correct mains connection, additional measures are necessary (e.g. use a suitable line filter).

2. Welding power leads
 - must be kept as short as possible
 - must run close together (to avoid EMF problems)
 - must be kept well apart from other leads
3. Equipotential bonding
4. Earthing of the workpiece
 - If necessary, establish an earth connection using suitable capacitors.
5. Shielding, if necessary
 - Shield off other nearby devices
 - Shield off entire welding installation

EMF measures

Electromagnetic fields may pose as yet unknown risks to health:

- effects on the health of others in the vicinity, e.g. wearers of pacemakers and hearing aids
- wearers of pacemakers must seek advice from their doctor before approaching the device or any welding that is in progress
- for safety reasons, keep distances between the welding cables and the welder's head/torso as large as possible
- do not carry welding cables and hosepacks over the shoulders or wind them around any part of the body

Specific hazards

Keep hands, hair, clothing and tools away from moving parts. For example:

- Fans
- Cogs
- Rollers
- Shafts
- Wirespools and welding wires

Do not reach into the rotating cogs of the wire drive or into rotating drive components.

Covers and side panels may only be opened/removed while maintenance or repair work is being carried out.

During operation

- Ensure that all covers are closed and all side panels are fitted properly.
- Keep all covers and side panels closed.

The welding wire emerging from the welding torch poses a high risk of injury (piercing of the hand, injuries to the face and eyes, etc.).

Therefore always keep the welding torch away from the body (devices with wire-feed unit) and wear suitable protective goggles.

Never touch the workpiece during or after welding - risk of burns.

Slag can jump off cooling workpieces. The specified protective equipment must therefore also be worn when reworking workpieces, and steps must be taken to ensure that other people are also adequately protected.

Welding torches and other parts with a high operating temperature must be allowed to cool down before handling.

Special provisions apply in areas at risk of fire or explosion - observe relevant national and international regulations.

Power sources for work in areas with increased electric risk (e.g. near boilers) must carry the "Safety" sign. However, the power source must not be located in such areas.

Risk of scalding from escaping coolant. Switch off cooling unit before disconnecting coolant flow or return lines.

Observe the information on the coolant safety data sheet when handling coolant. The coolant safety data sheet may be obtained from your service centre or downloaded from the manufacturer's website.

Use only suitable load-carrying equipment supplied by the manufacturer when transporting devices by crane.

- Hook chains and/or ropes onto all suspension points provided on the load-carrying equipment.
 - Chains and ropes must be at the smallest angle possible to the vertical.
 - Remove gas cylinder and wire-feed unit (MIG/MAG and TIG devices).
-

If the wire-feed unit is attached to a crane holder during welding, always use a suitable, insulated wirefeeder hoisting attachment (MIG/MAG and TIG devices).

If the device has a carrying strap or handle, this is intended solely for carrying by hand. The carrying strap is not to be used if transporting with a crane, counterbalanced lift truck or other mechanical hoist.

All lifting accessories (straps, handles, chains, etc.) used in connection with the device or its components must be tested regularly (e.g. for mechanical damage, corrosion or changes caused by other environmental factors).

The testing interval and scope of testing must comply with applicable national standards and directives as a minimum.

Odourless and colourless shielding gas may escape unnoticed if an adapter is used for the shielding gas connection. Prior to assembly, seal the device-side thread of the adapter for the shielding gas connection using suitable Teflon tape.

Requirement for the shielding gas

Especially with ring lines, contaminated shielding gas can cause damage to equipment and reduce welding quality.

Meet the following requirements regarding shielding gas quality:

- Solid particle size < 40 µm
 - Pressure condensation point < -20 °C
 - Max. oil content < 25 mg/m³
-

Use filters if necessary.

Danger from shielding gas cylinders

Shielding gas cylinders contain gas under pressure and can explode if damaged. As the shielding gas cylinders are part of the welding equipment, they must be handled with the greatest of care.

Protect shielding gas cylinders containing compressed gas from excessive heat, mechanical impact, slag, naked flames, sparks and arcs.

Mount the shielding gas cylinders vertically and secure according to instructions to prevent them falling over.

Keep the shielding gas cylinders well away from any welding or other electrical circuits.

Never hang a welding torch on a shielding gas cylinder.

Never touch a shielding gas cylinder with an electrode.

Risk of explosion - never attempt to weld a pressurised shielding gas cylinder.

Only use shielding gas cylinders suitable for the application in hand, along with the correct and appropriate accessories (regulator, hoses and fittings). Only use shielding gas cylinders and accessories that are in good condition.

Turn your face to one side when opening the valve of a shielding gas cylinder.

Close the shielding gas cylinder valve if no welding is taking place.

If the shielding gas cylinder is not connected, leave the valve cap in place on the cylinder.

The manufacturer's instructions must be observed as well as applicable national and international regulations for shielding gas cylinders and accessories.

Safety measures at the installation location and during transport

A device toppling over could easily kill someone. Place the device on a solid, level surface such that it remains stable

- The maximum permissible tilt angle is 10°.
-

Special regulations apply in rooms at risk of fire or explosion

- Observe relevant national and international regulations.
-

Use internal directives and checks to ensure that the workplace environment is always clean and clearly laid out.

Only set up and operate the device in accordance with the degree of protection shown on the rating plate.

When setting up the device, ensure there is an all-round clearance of 0.5 m (1 ft. 7.69 in.) to ensure that cooling air can flow in and out freely.

When transporting the device, observe the relevant national and local guidelines and accident prevention regulations. This applies especially to guidelines regarding the risks arising during transport.

Do not lift or transport operational devices. Switch off devices before transport or lifting.

Before transporting the device, allow coolant to drain completely and detach the following components:

- Wirefeeder
 - Wirespool
 - Shielding gas cylinder
-

After transporting the device, the device must be visually inspected for damage before commissioning. Any damage must be repaired by trained service technicians before commissioning the device.

Safety measures in normal operation

Only operate the device when all safety devices are fully functional. If the safety devices are not fully functional, there is a risk of

- injury or death to the operator or a third party
 - damage to the device and other material assets belonging to the operator
 - inefficient operation of the device
-

Any safety devices that are not functioning properly must be repaired before switching on the device.

Never bypass or disable safety devices.

Before switching on the device, ensure that no one is likely to be endangered.

Check the device at least once a week for obvious damage and proper functioning of safety devices.

Always fasten the shielding gas cylinder securely and remove it beforehand if the device is to be transported by crane.

Only the manufacturer's original coolant is suitable for use with our devices due to its properties (electrical conductivity, anti-freeze agent, material compatibility, flammability, etc.).

Only use suitable original coolant from the manufacturer.

Do not mix the manufacturer's original coolant with other coolants.

Only connect the manufacturer's system components to the cooling circuit.

The manufacturer accepts no liability for damage resulting from use of other system components or a different coolant. In addition, all warranty claims will be forfeited.

Cooling Liquid FCL 10/20 does not ignite. The ethanol-based coolant can ignite under certain conditions. Transport the coolant only in its original, sealed containers and keep well away from any sources of ignition.

Used coolant must be disposed of properly in accordance with the relevant national and international regulations. The coolant safety data sheet may be obtained from your service centre or downloaded from the manufacturer's website.

Check the coolant level before starting to weld, while the system is still cool.

Commissioning, maintenance and repair

It is impossible to guarantee that bought-in parts are designed and manufactured to meet the demands made of them, or that they satisfy safety requirements.

- Use only original spare and wearing parts (also applies to standard parts).
- Do not carry out any modifications, alterations, etc. to the device without the manufacturer's consent.
- Components that are not in perfect condition must be replaced immediately.
- When ordering, please give the exact designation and part number as shown in the spare parts list, as well as the serial number of your device.

The housing screws provide the ground conductor connection for earthing the housing parts.

Only use original housing screws in the correct number and tightened to the specified torque.

Safety inspection

The manufacturer recommends that a safety inspection of the device is performed at least once every 12 months.

The manufacturer recommends that the power source be calibrated during the same 12-month period.

A safety inspection should be carried out by a qualified electrician

- after any changes are made
- after any additional parts are installed, or after any conversions
- after repair, care and maintenance has been carried out
- at least every twelve months.

For safety inspections, follow the appropriate national and international standards and directives.

Further details on safety inspection and calibration can be obtained from your service centre. They will provide you on request with any documents you may require.

Disposal

Do not dispose of this device with normal domestic waste! To comply with the European Directive on Waste Electrical and Electronic Equipment and its implementation as national law, electrical equipment that has reached the end of its life must be collected

separately and returned to an approved recycling facility. Any device that you no longer require must either be returned to your dealer or given to one of the approved collection and recycling facilities in your area. Ignoring this European Directive may have potentially adverse effects on the environment and your health!

Safety symbols

Devices with the CE mark satisfy the essential requirements of the low-voltage and electromagnetic compatibility directives (e.g. relevant product standards of the EN 60 974 series).

Fronius International GmbH hereby declares that the device is compliant with Directive 2014/53/EU. The full text on the EU Declaration of Conformity can be found at the following address: <http://www.fronius.com>

Devices marked with the CSA test mark satisfy the requirements of the relevant standards for Canada and the USA.

Data protection

The user is responsible for the safekeeping of any changes made to the factory settings. The manufacturer accepts no liability for any deleted personal settings.

Copyright

Copyright of these operating instructions remains with the manufacturer.

The text and illustrations are all technically correct at the time of printing. We reserve the right to make changes. The contents of the operating instructions shall not provide the basis for any claims whatsoever on the part of the purchaser. If you have any suggestions for improvement, or can point out any mistakes that you have found in the instructions, we will be most grateful for your comments.

General

Principle

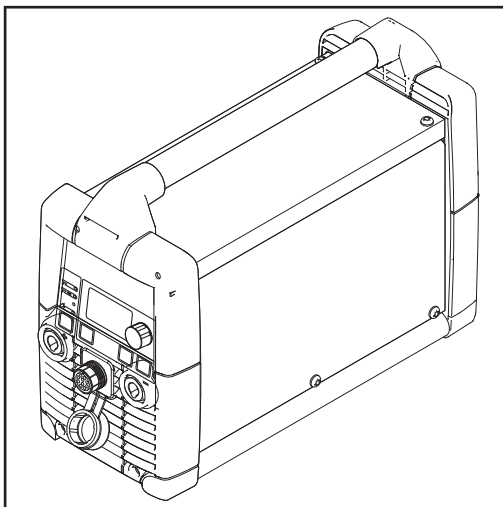

TransPocket 2500 Comfort

The TransPocket (TP) 2500 Comfort and TransPocket (TP) 3500 Comfort power sources offer excellent ignition and welding properties, while being extremely lightweight with very small dimensions.

An electronic regulator adapts the power source characteristic to the electrode to be welded, and thus ensures a stable arc and optimum characteristic.

Device concept

The TP 2500 / 3500 Comfort power sources have connection sockets with bayonet fixing, a powder-coated sheet steel housing with stainless steel runners and the controls are protected by plastic frames. The handle makes it easy to carry, both in-house or on-site.

Application areas

As compact units, the TP 2500 Comfort and TP 3500 Comfort power sources are especially well suited to portable use on building sites and for assembly work. But even when used as stationary units in workshops or industrial facilities, the machines are powerful and economical alternatives.

Control elements and connections

Safety

WARNING!

Danger due to incorrect operation and incorrectly performed work.

This can result in serious injury and damage to property.



- ▶ All the work and functions described in this document must only be carried out by trained and qualified personnel.
- ▶ Read and understand this document.
- ▶ Read and understand all the Operating Instructions for the system components, especially the safety rules.

As a result of software updates, you may find that there are functions available on your device that are not described in these Operating Instructions, or vice versa. Certain illustrations may also differ slightly from the actual controls on your device, but these controls function in exactly the same way.

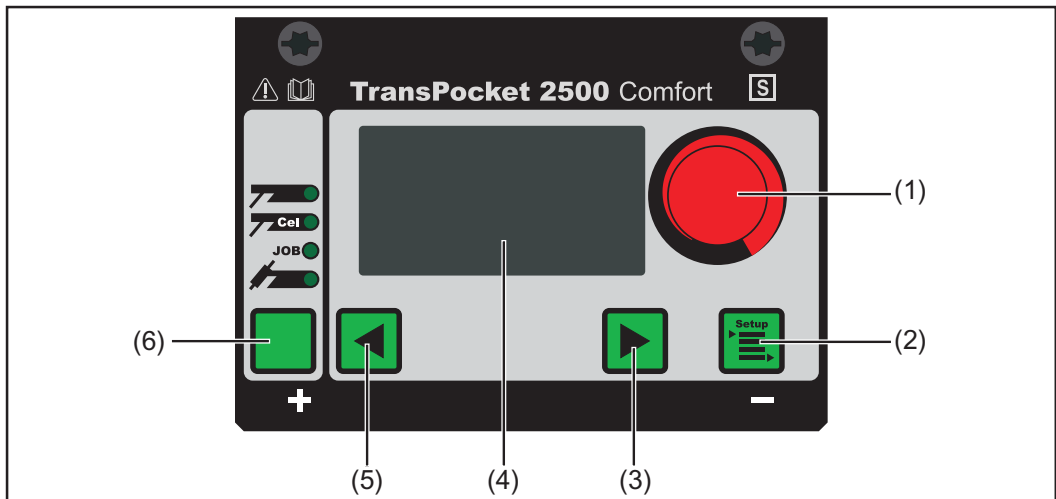
Controls



Controls and indicators on the control panel

- (1) **Adjusting dial**
 - Turn the adjusting dial to select parameters
 - Press the dial to confirm a selection from the menu or to accept values
- (2) **Setup button**
 - Calls up the Setup menu in the set process
- (3) **Right button**
 - Navigation in the menu
- (4) **Display**
- (5) **Left button**
 - Navigation in the menu
- (6) **Process button**
 - Selects the welding process
 -  Rod electrode (MMA) welding
 -  MMA welding with CEL electrode

JOB ● Job welding

⚡ TIG welding

The selected welding process remains in memory even after the mains plug is disconnected.

Connections

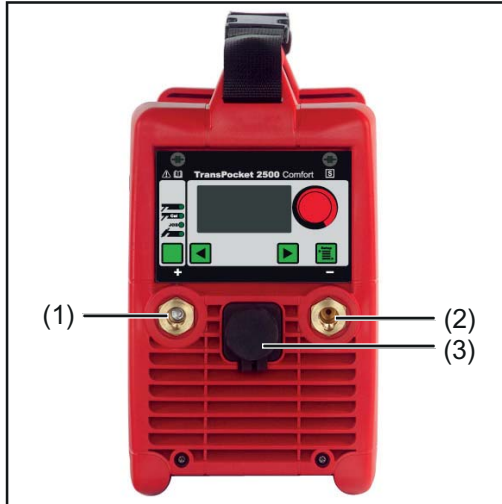

Connections on the front

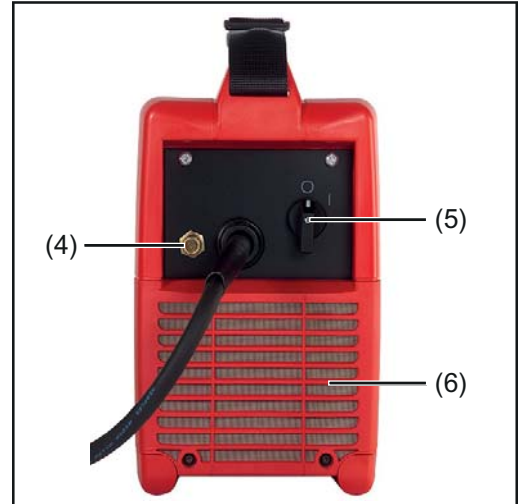

Connections on the back

(1) (+) Current socket with bayonet latch

Connects the

- rod electrode or grounding/earthing cable for MMA welding, depending on the type of electrode being used
- the grounding (earthing) cable when TIG welding

(2) (-) Current socket with bayonet latch

Connects the

- rod electrode or grounding/earthing cable for MMA welding, depending on the type of electrode being used
- Welding torch in TIG welding (current connection)

(3) Remote control unit connection socket

For connecting a remote control unit

(4) Shielding gas connection socket

For connecting the gas hose

(5) Mains switch

(6) Dust filter

In the fan intake area; prevents contamination of the housing interior if large amounts of dust accumulate

NOTE!

The manufacturer strongly recommends that a dust filter be used with the power source.

Before commissioning

Safety



WARNING!

Danger due to incorrect operation and incorrectly performed work.

This can result in serious injury and damage to property.

- ▶ All the work and functions described in this document must only be carried out by trained and qualified personnel.
 - ▶ Read and understand this document.
 - ▶ Read and understand all the Operating Instructions for the system components, especially the safety rules.
-

Proper use

The power source is intended exclusively for MMA welding and TIG welding in conjunction with system components from Fronius.

Utilisation for any other purpose, or in any other manner, shall be deemed to be not in accordance with the intended purpose.

The manufacturer shall not be held liable for any damages arising from such usage.

Proper use also includes:

- carefully reading these operating instructions
 - following all the instructions and safety rules in these operating instructions
 - performing all stipulated inspection and maintenance work
-

Setup regulations



WARNING!

Danger from machines falling or toppling over.

This can result in serious injury and damage to property.

- ▶ Place devices on a solid, level surface in such a way that they remain stable.
-

The device is tested to IP 23 protection, meaning:

- Protection against penetration by solid foreign bodies with diameters > 12.5 mm (0.49 in.)
- Protected against spraywater at any angle up to 60° to the vertical

Cooling air

The device must be set up in such a way that cooling air can flow freely through the slots in the front and rear panels.

Dust

Ensure that metallic dust is not sucked into the system by the fan, when carrying out grinding for example.

Outdoor operation

The device can be set up and operated outdoors in accordance with IP23 degree of protection. Avoid direct wetting (e.g. from rain).

Mains connection

The devices are designed for the mains voltage specified on the rating plate. The fuse protection required for the mains lead can be found in the "Technical data" section. If there is no mains cable or mains plug on your device, fit one that conforms to national standards.

NOTE!

An inadequately dimensioned electrical installation can cause serious damage.
The mains lead and its fuse must be dimensioned to suit the local power supply. The technical data shown on the rating plate applies.

Changing mains voltage (only MVm versions)

General remarks MVm machines (MultiVoltage manual) are suitable for operation with a mains voltage of 380 - 460V and a mains voltage of 200 - 240V.

NOTE!

Machines are supplied with the 380 - 460V setting as standard.

If the mains voltage range needs to be reset, this must be done manually.

Detailed information can be found in the "Technical data" chapter.

Mains voltage tolerance range

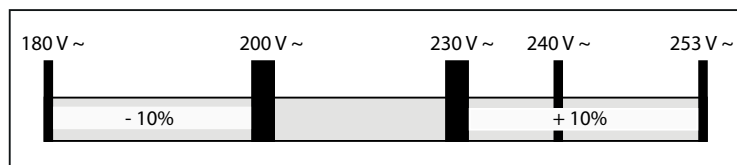

200 V - 240 V

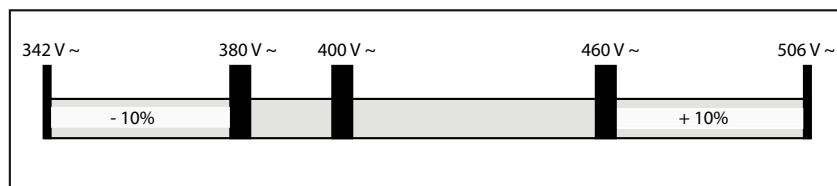

380 V - 460 V

Changing mains voltage

WARNING!

An electric shock can be fatal.

Before opening the device

- ▶ Move the mains switch to the "O" position
- ▶ Unplug the device from the mains
- ▶ Put up an easy-to-understand warning sign to stop anybody inadvertently switching it back on again
- ▶ Using a suitable measuring instrument, check to make sure that electrically charged components (e.g. capacitors) have been discharged

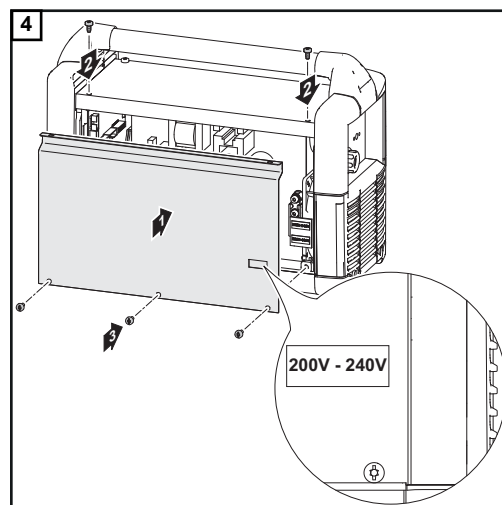
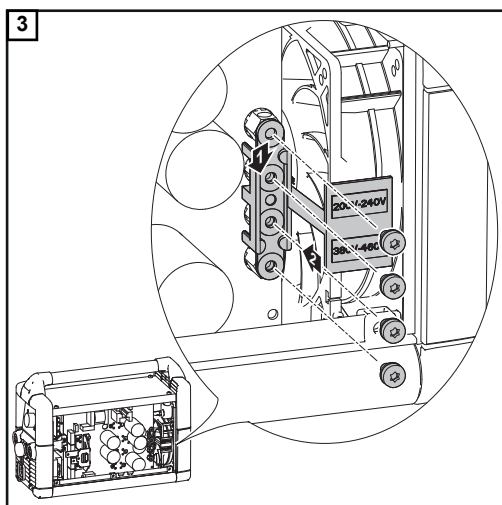
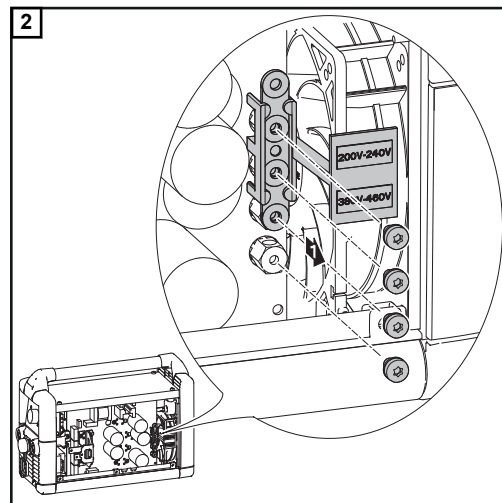
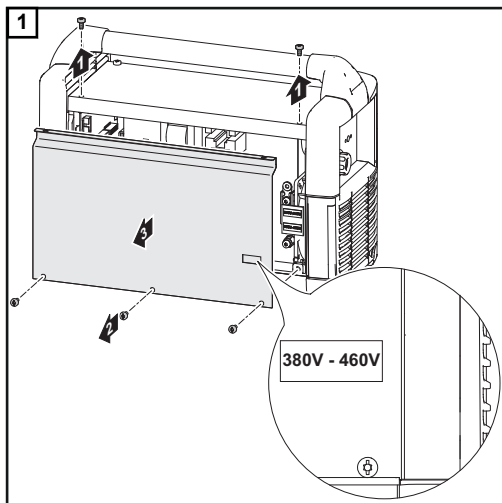

Single-phase operation

MVm machines can be used in single phase operation (e.g. 1x230V) if required. However, this reduces the welding current range. Please see the "Technical Data" section for the relevant performance data. Fit the mains cable and mains plug in accordance with the applicable national standards.

MMA welding

Safety



WARNING!

Danger from incorrect operation.

This can result in serious injury and damage to property.

- ▶ Do not use the functions described here until you have fully read and understood the following documents:
 - ▶ These Operating Instructions
 - ▶ All the Operating Instructions for the system components, especially the safety rules
-



WARNING!

Risk of electric shock.

An electric shock can be fatal. If the device is plugged into the mains during installation, there is a high risk of serious injury and damage to property.

- ▶ Only carry out work on the device if the mains switch is in the "O" position.
 - ▶ Only carry out work on the charger when it has been disconnected from the mains supply.
-

Welding parameters: Display and navigation

The welding parameters for rod electrode (MMA) welding are displayed when the „MMA welding“ or „MMA welding with CEL electrode“ process is selected.



Use the Left and Right buttons to navigate through the welding parameters.



Welding parameters

Starting current

70 % 88V

The diagram shows a control panel with a slider set to 70%. A downward arrow points to the slider. To the right of the slider is a small 'm' symbol. The panel is flanked by left and right arrow symbols.

Starting current: Starting current < Main current (soft start)

Starting current

100 % 88V

The diagram shows a control panel with a slider set to 100%. A downward arrow points to the slider. To the right of the slider is a small 'm' symbol. The panel is flanked by left and right arrow symbols.

Starting current: Starting current = Main current

Starting current

130 % 88V

The diagram shows a control panel with a slider set to 130%. A downward arrow points to the slider. To the right of the slider is a small 'm' symbol. The panel is flanked by left and right arrow symbols.

Starting current: Starting current > Main current (hot start)

Unit	% (of main current)
Setting range	10 - 200
Factory setting	150

Main current

10 A 88V

The diagram shows a control panel with a slider set to 10A. A downward arrow points to the slider. To the right of the slider is a small 'm' symbol. The panel is flanked by left and right arrow symbols.

Main current: Starting current < Main current (soft start)

Main current

10 A 88V

The diagram shows a control panel with a slider set to 10A. A downward arrow points to the slider. To the right of the slider is a small 'm' symbol. The panel is flanked by left and right arrow symbols.

Main current: Starting current = Main current

Main current

10 A 88V

The diagram shows a control panel with a slider set to 10A. A downward arrow points to the slider. To the right of the slider is a small 'm' symbol. The panel is flanked by left and right arrow symbols.

Main current: Starting current > Main current (hot start)

Unit	A
Setting range	TP 2500 Comfort 10 - 250 TP 3500 Comfort 10 - 350
Factory setting	-

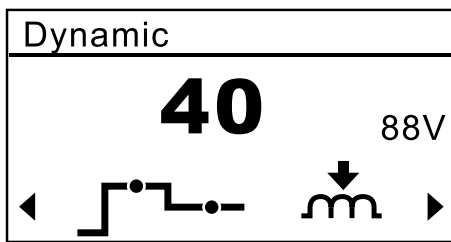

Arc force dynamic, e.g. if starting current > main current

To obtain optimum welding results, it will sometimes be necessary to adjust the Dynamic function.

Unit	-
Setting range	0 - 100
Factory setting	20

0	Soft, low-spatter arc
100	Harder, more stable arc

Working principle:

At the instant of droplet transfer or when a short-circuit occurs, there is a temporary rise in the current intensity. To obtain a stable arc, the welding current is increased temporarily. If the rod electrode threatens to sink into the weld pool, this measure prevents the weld pool solidifying, as well as preventing more prolonged short-circuiting of the arc. This largely prevents the rod electrode from "sticking".

Preparations

1. Plug the welding power-lead into the current socket, depending upon which type of electrode is to be used, and latch it by turning it clockwise
2. Plug the grounding cable into the current socket, depending on which type of electrode is to be used, and latch it by turning it clockwise
3. Plug in the mains plug

MMA welding

CAUTION!

Risk of injury and damage due to electric shock.

As soon as the mains switch is in the - I - position, the rod electrode in the electrode holder is LIVE. Make sure that the rod electrode does not touch any persons or electrically conducting or earthed parts (e.g. the housing etc.)

- 1 Move the mains switch to the - I - position

The Fronius logo appears on the display for roughly 1 second.

- 2 Press the Process button to select one of the following processes:

 MMA welding

 MMA welding with CEL electrodes

NOTE!

- MMA welding with hot start is recommended for welding rutile electrodes.
- MMA welding with soft start is recommended for welding basic electrodes.
- The MMA welding process with CEL electrode should always be selected for welding cellulose electrodes.

The graphic for the MMA welding parameters appears on the display, e.g.:

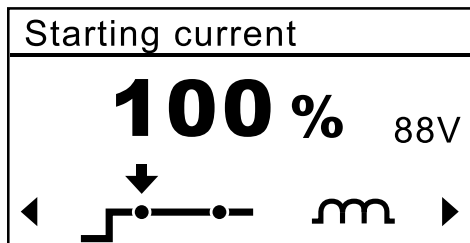



 **3** Press the Right button to select the individual welding parameters

 **4** Turn the dial to change the value of the welding parameter

 **5** Turn the dial to change the value of the welding parameter:
- Press the Setup button

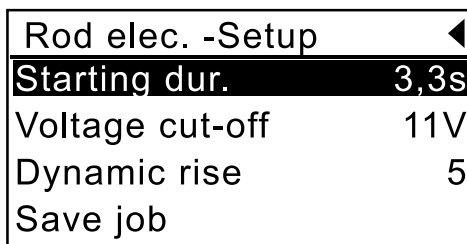
The relevant menu is displayed, e.g.:



 - Use the adjusting dial to select the parameter

 - Press the dial to change a parameter

 - Turn the dial to change the value of the parameter

 - Press the dial to accept the value of the parameter

 - Press the Setup button to exit the Setup menu

All parameter command values that were set using the dial will be stored until the next time they are changed. This applies even if the power source is switched off and on again in the meantime.

6 Start welding

**HotStart function
(used with rutile
and Cel processes)**

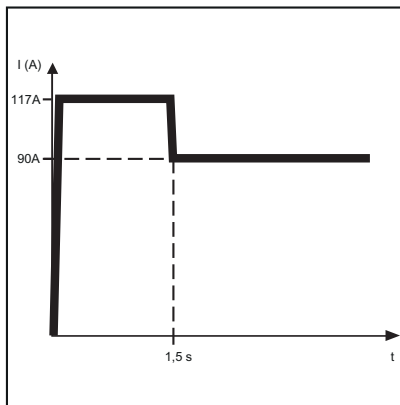

Example of HotStart function

Mode of operation:

The welding current is raised to a specific value for 1.5 seconds. This value is around 30% higher than the set welding current

Example: 90 A was set on the adjuster.
The HotStart current is $90\text{ A} + 30\% = 117\text{ A}$

IMPORTANT! If the welding current is set to 192 A or higher, the HotStart current is limited to 250 A.

Benefits:

- Improved ignition properties, even when using electrodes with poor ignition properties
- Better fusion of the base material during the start-up phase, meaning fewer cold-shut defects
- Largely prevents slag inclusions

**SoftStart function
(used with basic
process)**

The SoftStart function is intended for basic electrodes. Ignition takes place at a low welding current. Once the arc is stable, the welding current continues to rise until it reaches the welding current command value.

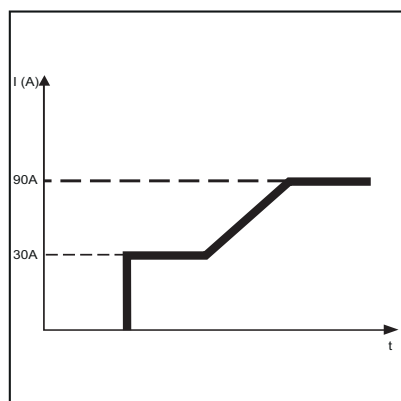

Example of SoftStart function

Benefits:

- Improved ignition properties for electrodes that ignite at low welding currents
- Largely prevents slag inclusions
- Reduces welding spatter

**Anti-stick func-
tion**

As the arc becomes shorter, the welding voltage may drop so far that the rod electrode will tend to stick.

The anti-stick function prevents the electrode from burning out. If the rod electrode begins to stick, the power source switches the welding current off after 1 second. After the rod electrode has been lifted off the workpiece, the welding operation can be continued without difficulty.

**Remote control
mode**

If there is a remote control unit connected to the remote control socket or if the TP09 wireless remote control unit is used, the symbol „EXT“ appears on the display:

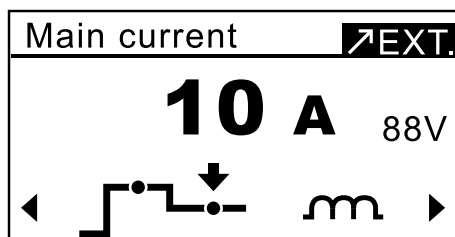

All the possible welding parameter settings are made via the remote control unit.

TIG welding

Safety



WARNING!

Danger from incorrect operation.

Operating the equipment incorrectly can cause serious injury and damage.

- ▶ Do not use the functions described here until you have read and completely understood these Operating Instructions.
- ▶ Do not use the functions described here until you have fully read and understood all of the Operating Instructions for the system components, in particular the safety rules.



WARNING!

Risk of electric shock.

An electric shock can be fatal. If the device is plugged into the mains during installation, there is a high risk of serious injury and damage to property.

- ▶ Only carry out work on the device if the mains switch is in the "O" position.
- ▶ Only carry out work on the charger when it has been disconnected from the mains supply.

Welding parameters and navigation

The welding parameters for TIG welding are displayed when you select the TIG welding process.



Use the Left and Right buttons to navigate through the welding parameters..



Welding parameters

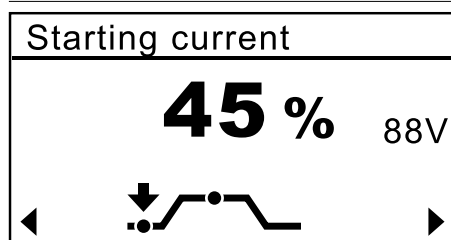

Unit	% (of main current)
Setting range	10 - 100
Factory setting	15

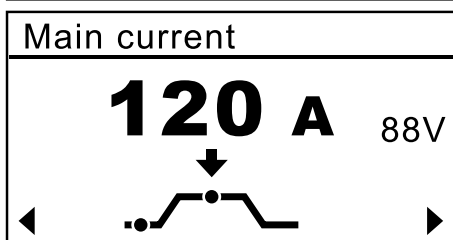

Unit	A
Setting range	TP 2500: 10 - 250 TP 3500: 10 - 350
Factory setting	-

Requirement The full range of functions for TIG welding can only be guaranteed if the Fronius TTG 2200 TCS welding torch is used.

- Preparations**
1. Move the mains switch to the - O - position
 2. Unplug the machine from the mains
 3. Disconnect the welding and earthing cables for MMA welding from the power source
 4. Plug the current plug of the TIG torch into the (-) current socket and turn it clockwise to latch it into place
 5. Plug the current plug of the grounding (earthing) cable into the (+) current socket and turn it clockwise to latch it into place

NOTE!

Do not use pure tungsten electrodes (colour-coded green) for TIG welding with the TP 2500 / 3500 Comfort.

6. Tool up the welding torch (see the instruction manual for the torch)
7. If you have a remote control unit, plug it into the remote control socket
8. Connect the workpiece to the ground (earth)
9. Attach the pressure regulator to the shielding gas cylinder
10. Connect the gas hose:

If you are using a gas-valve torch:

- Connect the gas hose of the gas-valve torch to the pressure regulator

If you are using the TTG 2200 TCS torch:

- Connect the gas hose to the pressure regulator
- Connect the gas hose to the shielding gas socket
- Tighten the union nut

11. Open the gas cylinder valve
12. Plug in the mains plug

Setting the shielding gas flow rate for a gas-valve torch

 **CAUTION!**

Risk of injury and damage due to electric shock.

As soon as the mains switch is in the - I - position, the tungsten electrode in the torch is LIVE. Make sure that the tungsten electrode does not touch any persons or electrically conducting or earthed parts (e.g. housing etc.)

1. Move the mains switch to the - I - position
2. Open the gas cylinder valve on the torch or press the torch trigger and set the desired gas flow rate at the pressure regulator

Setting the shielding gas flow rate for the TTG 2200 TCS torch

 **CAUTION!**

Risk of injury and damage due to electric shock.

As soon as the mains switch is in the - I - position, the tungsten electrode in the torch is LIVE. Make sure that the tungsten electrode does not touch any persons or electrically conducting or earthed parts (e.g. housing etc.)

-  Move the mains switch to the - I - position

The Fronius logo appears on the display for roughly 1 second.



-  Press and hold the Process button



-  Press the Setup button

The power source is now in the Service menu:

Service	◀
Language	GB
Op. Circ Voltage	90V
Anti-stick	On
Contrast	21



-  Turn the dial to select 'Sol.ValveTest'

Service	◀
Anti-stick	On
Contrast	21
Fan test	Off
Sol. Valve test	Off



- 5 Press the dial to set the parameter

You can now change the parameter value.

Service	◀
Anti-stick	On
Contrast	21
Fan test	Off
Sol. Valve test	Off



- 6 Turn the dial to set the 'Sol.ValveTest' parameter to 'On'

Service	◀
Anti-stick	On
Contrast	21
Fan test	Off
Sol. Valve test	On



- 7 Press the dial to accept the set parameter value

Service	◀
Anti-stick	On
Contrast	21
Fan test	Off
Sol. Valve test	On

The gas solenoid valve picks up

- 8 Set the shielding gas flow rate on the pressure controller



- 9 Press the Setup button

A graphic of the welding parameters appears on the display, e.g.:

Starting current	
100 % 88V	
↓	
◀	▶

TIG welding

- 1 Press the Process button to select the TIG welding process



The graphic for the TIG welding parameters appears on the display:

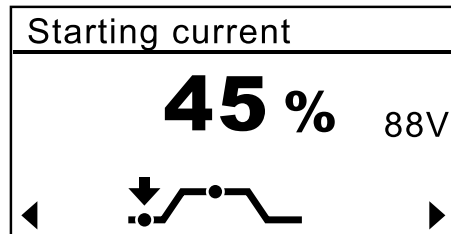

- 2 Press the Right button to select the individual welding parameters



- 3 Turn the dial to change the value of the welding parameter



- 4 Set any other parameters in the Setup menu:
Press the Setup button

The relevant menu is displayed, e.g.:

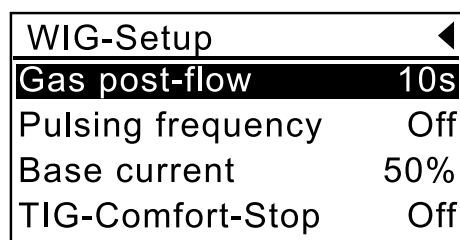

- Use the adjusting dial to select the parameter



- Press the dial to change a parameter



- Turn the dial to change the value of the parameter



- Press the dial to accept the value of the parameter



- Press the Setup button to exit the Setup menu

All parameter command values that were set using the dial will be stored until the next time they are changed. This applies even if the power source is switched off and on again in the meantime.

- 5 Start the welding process (ignite the arc)

Adjusting welding current, igniting the arc

1. Select amperage using welding current adjuster
2. Place the gas nozzle in the ignition location so that there is a gap of 2 - 3 mm (0.08 - 0.12 in.) between the tungsten tip and the workpiece Gap exists
3. Gradually tilt up the welding torch until the tungsten electrode touches the workpiece

IMPORTANT! As long as the torch is touching the workpiece, the gas pre-flow takes place automatically.

If the torch and workpiece remain in contact for more than 3 seconds, the welding current switches off automatically. Place the gas nozzle on the ignition location again.

4. Raise the torch and tilt it into the normal position - the arc now ignites
5. Carry out welding

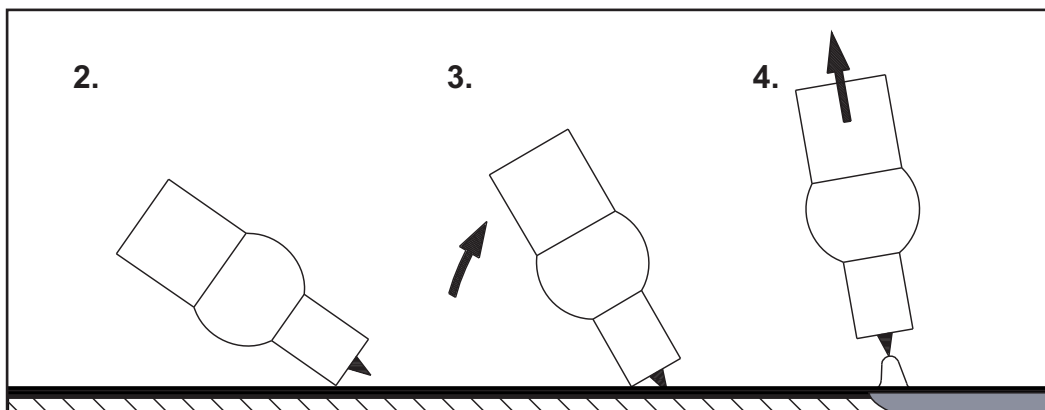

Remote control mode

If there is a remote control unit connected to the remote control socket or if the TP09 wireless remote control unit is used, the symbol „EXT“ appears on the display:

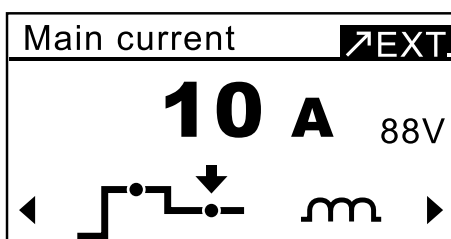

All the possible welding parameter settings are made via the remote control unit.

TIG Comfort Stop function

The "TIG Comfort Stop" function (TCS) is only available with the TP 2500/3500 TIG power source. The TIG-Comfort-Stop function is deactivated as standard. Activating and setting the TIG Comfort Stop function is described in the "The Setup menu" section.

If the TIG Comfort Stop function is deactivated, end crater filling through current decrease or gas shielding of the end crater does not occur. To finish welding lift the torch away from the workpiece until the arc goes out.

To finish welding with activated TCS function, proceed as follows:

1. Welding
2. During welding, raise the welding torch
 - The arc length is increased significantly
3. Lower the welding torch
 - The arc length is decreased significantly
 - This triggers the TIG Comfort Stop function
4. Keep the welding torch at the same height
 - The welding current continuously decreases until it reaches the minimum welding current (10 A) (downslope)
 - The minimum welding current is held constant for 0.2 seconds
 - Arc goes out
5. Wait for the gas post-flow time to finish, and lift the torch off the workpiece

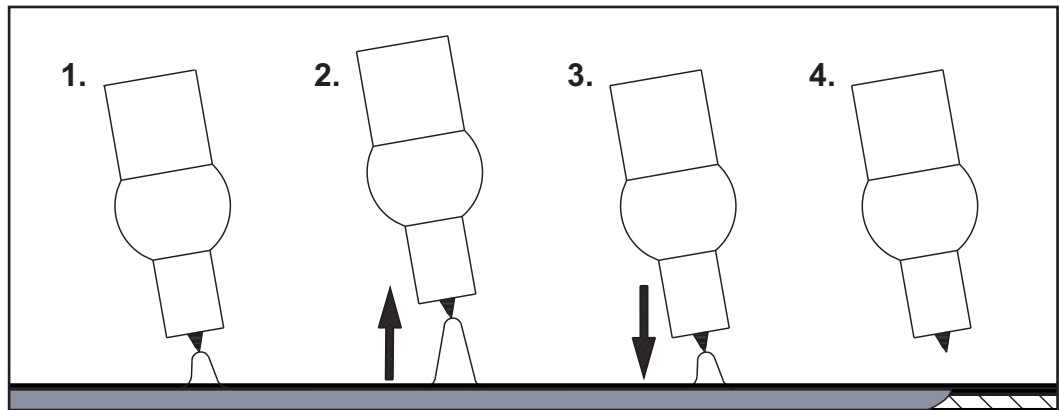

Downslope:

The downslope depends on the welding current selected and cannot be adjusted. The duration of the downslope between the following values must be extrapolated.

- Downslope with low welding current (10 A): 0.4 seconds
- Downslope with maximum welding current (250 A): 10 seconds

Gas post-flow time:

The gas post-flow time depends on the welding current selected and cannot be adjusted.

- Gas post-flow time with minimum welding current (10 A): 3 seconds
- Gas post-flow time with maximum welding current (250 A): 15 seconds

The following diagram shows the welding current sequence and the gas flow when the TIG Comfort Stop function is activated:

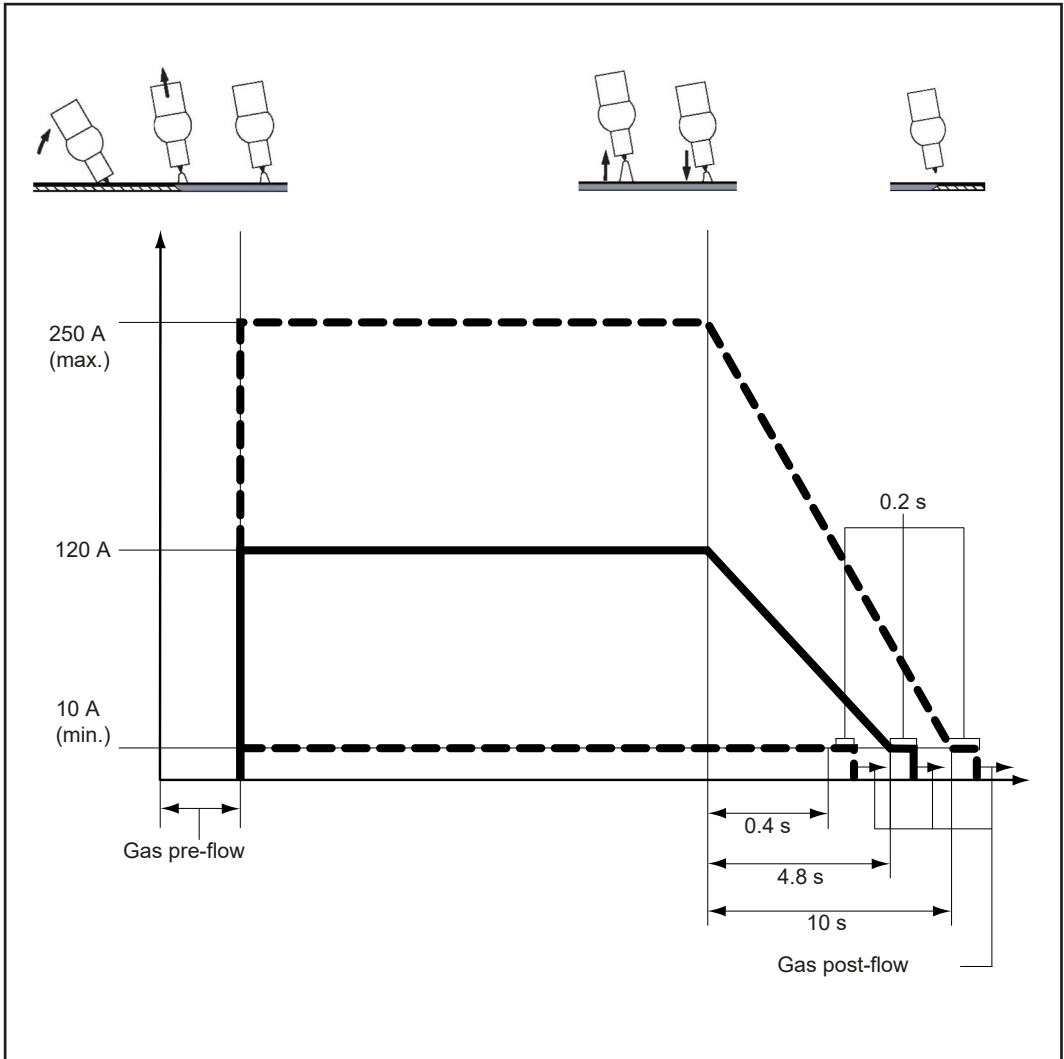

TIG Comfort Stop: Welding current and gas flow

Welding job

Safety



WARNING!

Danger from incorrect operation.

Possible serious injury and damage to property.

- ▶ Do not use the functions described here until you have read and completely understood these Operating Instructions.
 - ▶ Do not use the functions described here until you have fully read and understood all of the Operating Instructions for the system components, in particular the safety rules!
-



WARNING!

An electric shock can be fatal.

If the power source is connected to the mains electricity supply during installation, there is a high risk of very serious injury and damage.

- ▶ Before carrying out any work on the device make sure that the power source mains switch is in the "O" position
 - ▶ Before carrying out any work on the device make sure that the power source is unplugged from the mains
-

Preparations

1. Set up and install the power source for the job to be welded
-

Job welding



CAUTION!

Risk of injury and damage due to electric shock.

As soon as the mains switch is in the - I - position, the rod electrode in the electrode holder or the tungsten electrode in the torch is LIVE. Make sure that rod or tungsten electrodes are not touching any persons or electrically conducting or earthed parts (e.g. housing etc.)

- 1** Move the mains switch to the - I - position

The Fronius logo appears on the display for roughly 1 second.



-  **2** Press the Process button to select the job welding process:

JOB ●

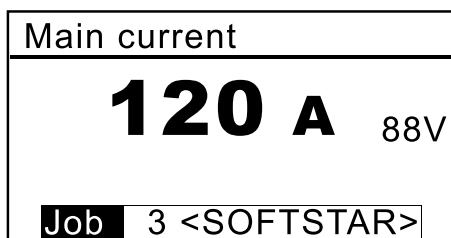
The display shows the last selected job, e.g.:



The LED on the process symbol for the process of the selected job lights up.

-   **3** Use the Left and Right buttons to select the job

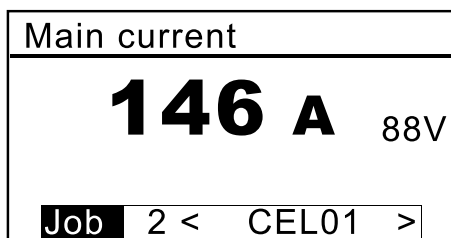

- 4** You can change the job using the Job correction function in the Service menu, e.g.:

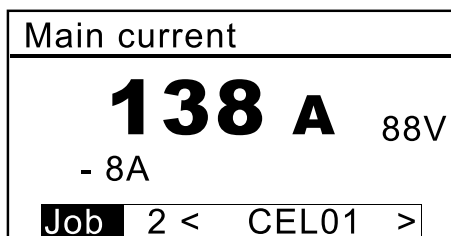

NOTE!

Before starting job welding, make sure that the power source is set up and installed to suit the job.

- 5** Start welding

Saving settings as a job

General remarks You can save settings and welding parameters in 20 jobs within the individual welding processes. You save settings as a job in the Setup menu for the process.

Storing settings as a job

-  **1** Press the Process button to select the process to be saved

The graphic shows the welding parameters.

-  **2** Press the Right button to select the welding parameters

-  **3** Turn the dial to set the welding parameters

-  **4** Press the Setup button

The Setup menu is displayed, e.g.:

Rod elec. -Setup	◀
Starting dur.	3,3s
Voltage cut-off	11V
Dynamic rise	5
Save job	

-  **5** Turn the dial to select 'Save job'

Rod elec. -Setup	◀
Starting dur.	3,3s
Voltage cut-off	11V
Dynamic rise	5
Save job	

-  **6** Press the dial

The first screen for saving a job is displayed:

Save job	◀
Job 1	< >
Job 2	< >
Job 3	< >
Job 4	< >



7 Turn the dial to select the job number under which you want to save the settings

Save job		
Job 1	<	>
Job 2	<	>
Job 3	<	>
Job 4	<	>

NOTE!

If you select an existing job, it will be overwritten without a prompt when you save.



8 Press the dial

The second screen for saving a job is displayed:

Save job		
Job 2	< _	>
A B C D E F G H I J K L M N O		
P Q R S T U V W X Y Z 0 1 2 3		
4 5 6 7 8 9 -		
	<input type="text"/>	OK



9 Turn the dial to select the letters for the job name



10 Press the dial to accept the letters

Save job		
Job 2	< L _	>
A B C D E F G H I J K L M N O		
P Q R S T U V W X Y Z 0 1 2 3		
4 5 6 7 8 9 -		
	<input type="text"/>	OK



To change a letter:

- Use the Left and Right buttons to move the cursor to the required position
- Overwrite the letters



To delete a letter:

- Use the Left and Right buttons to move the cursor to the required position



- Turn the dial to select the spacebar

Save job ◀

Job 2 < LEFTUP1X >

ABCDEFGHIJKLMNO

PQRSTUVWXYZ0123

456789- OK

Cursor

Spacebar



- Press the dial

The required letter is deleted:

Save job ◀

Job 2 < LEFTUP1 >

ABCDEFGHIJKLMNO

PQRSTUVWXYZ0123

456789- OK



- 11** Turn the dial to select 'OK'



- 12** Press the dial

The settings are saved, and the graphic showing the welding parameters is displayed.

The Setup menu

General remarks On the TP 2500 Comfort and TP 3500 Comfort power sources, there is a separate Setup menu for each welding process.

Opening a Setup menu

- 1 Press the Process button to select the process
 - For the MMA welding, MMS welding with CEL electrode and TIG welding processes, the graphic is displayed with the welding parameters.
 - For the Job welding process, the last selected job is displayed.

- 2 Press the Setup button

The Setup menu is displayed, e.g.:

Rod elec. -Setup	◀
Starting dur.	3,3s
Voltage cut-off	11V
Dynamic rise	5
Save job	

Selecting and setting parameters



- 1 Turn the dial to set a parameter:

Rod elec. -Setup	◀
Starting dur.	3,3s
Voltage cut-off	11V
Dynamic rise	5
Save job	



- 2 Press the dial to set the parameter

You can now change the parameter value:

Rod elec. -Setup	◀
Starting dur.	3,3s
Voltage cut-off	11V
Dynamic rise	5
Save job	



3 Turn the dial to change the value of the parameter

Rod elec. -Setup	◀
Starting dur.	3,3s
Voltage cut-off	30V
Dynamic rise	5
Save job	



4 Press the dial to accept the set parameter value

Rod elec. -Setup	◀
Starting dur.	3,3s
Voltage cut-off	30V
Dynamic rise	5
Save job	

IMPORTANT! Set parameters remain in memory even if the mains plug is disconnected.

Exiting a Setup menu



1 Press the Setup button

or



- Turn the dial to select the arrow symbol

Rod elec. -Setup	◀
Starting dur.	3,3s
Voltage cut-off	30V
Dynamic rise	5
Save job	



- Press the dial

The graphic shows the welding parameters.

Overview

'The Setup menu' is made up of the following sections:

- MMA setup
- Cel-electrode setup (Cel-elec.-Setup)
- Job setup
- TIG setup

Easy Mode

- General remarks** Easy Mode is a simplified way to operate the power source.
The following functions and controls are not available in Easy Mode:
- The job welding process
 - Navigation with the Left and Right buttons
 - The Setup button
 - The dial press function

Activating Easy Mode

1 Open the Service menu



2 Turn the dial to select 'Easy Mode'

Service	◀
Job correction	10%
Easy Mode	Off
Inverse Display	Off
Factory	



3 Press the dial

You can now activate 'Easy Mode'

Service	◀
Job correction	10%
Easy Mode	Off
Inverse Display	Off
Factory	



4 Turn the dial to select 'On'

Service	◀
Job correction	10%
Easy Mode	On
Inverse Display	Off
Factory	



5 Press the dial to activate 'Easy Mode'

The Service menu is displayed:

Service	◀
Job correction	10%
Easy Mode	On
Inverse Display	Off
Factory	



6 Press the Setup button

The power source switches to Easy Mode and the last selected process is displayed:

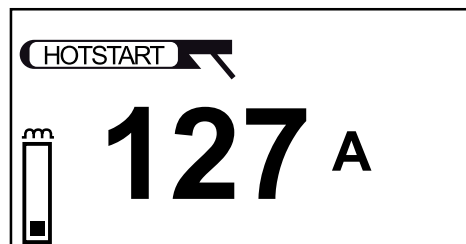

E.g.: Easy Mode for the Hot start process with MMA welding

Selecting the welding process in Easy Mode

In Easy Mode, it is generally the Process button that is used to select the welding process.

The following welding processes are available in Easy Mode:

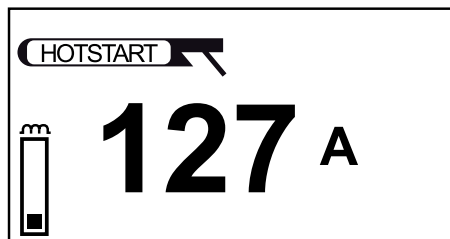

MMA welding - hot start

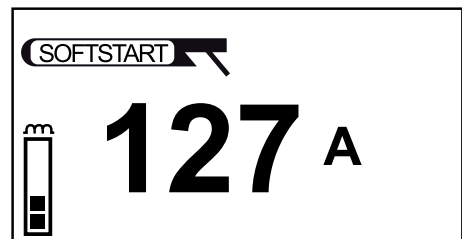

MMA welding - soft start

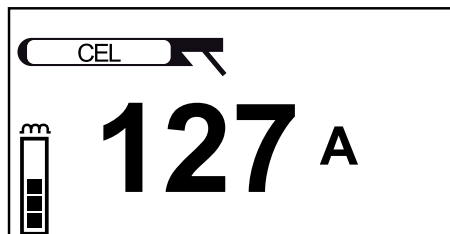

MMA welding with CEL electrodes

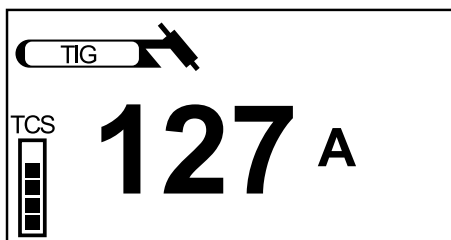

TIG welding TIG pulsed-arc welding

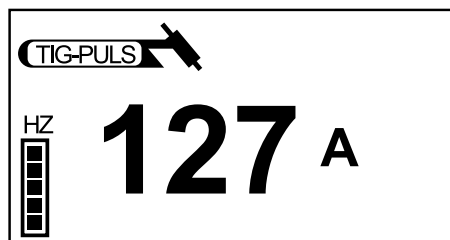











WIG Impuls-Lichtbogen Schweißen

 1 Press the Process button to select the welding process

When you select a process,

- the LED lights up in the corresponding symbol
- the relevant Easy Mode screen is displayed

	Main current	Dynamic	TCS - TIG-ComfortStop	Pulsing frequency
MMA welding				
MMA welding with CEL electrodes			-	-
TIG welding		-		-
TIG pulsed arc welding		-	-	

 Turn the dial to set the parameter

 Set the parameters by pressing and holding the Process button:

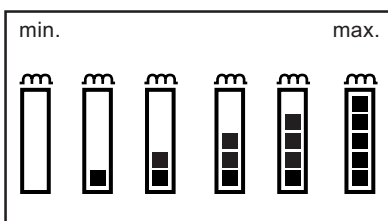

The values of the Dynamic, TCS and Pulsing frequency parameters are shown as bar displays in Easy Mode. Press and hold the Process button to set the parameters. The number of bars increases or decreases according to how long the Process button is held down.

Assigned values for the Dynamic parameter:

0 = Soft, low-spatter arc

5 = Hard, stable arc

Assigned values for the TCS parameter:

0 = TIG-Comfort Stop Off

1 = Small increase in length of arc required

5 = Large increase in length of arc required

Assigned values for the Pulsing frequency parameter:

0 = 0,5 Hz

- 1 = 1 Hz
- 2 = 2 Hz
- 3 = 4 Hz
- 4 = 10 Hz
- 5 = 60 Hz

NOTE!

The following values are stored in Easy Mode for the starting current:

- ▶ for MMA welding - hot start: Main current + 30 %
- ▶ for MMA welding - soft start: ¹⁾
- ▶ for TIG welding: ¹⁾
- ▶ for TIG pulsed-arc welding: ¹⁾

¹⁾ Depending on what welding current has been set, the starting current values varies.

The starting current cannot be changed in Easy Mode.

Deactivating Easy Mode



1 Press and hold the Process button



2 Press the Setup button

The Service menu is displayed:

Service	◀
Language	GB
Op. Circ Voltage	90V
Anti-stick	On
Contrast	21



3 Turn the dial to select 'Easy Mode'

Service	◀
Job correction	10%
Easy Mode	On
Inverse Display	Off
Factory	



4 Press the dial

You can now deactivate 'Easy Mode'

Service	◀
Job correction	10%
Easy Mode	On
Inverse Display	Off
Factory	



5 Turn the dial to select 'Off'

Service	◀
Job correction	10%
Easy Mode	Off
Inverse Display	Off
Factory	



6 Press the dial to deactivate 'Easy Mode'

Service	◀
Job correction	10%
Easy Mode	Off
Inverse Display	Off
Factory	



7 Press the Setup button

The power source switches to Comfort Mode and the graph with welding parameters for the last selected process is displayed:

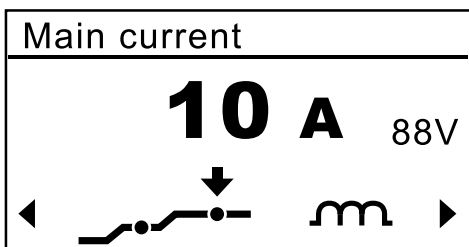

MMA setup

MMA setup

Rod elec. -Setup	◀
Starting dur.	3,3s
Voltage cut-off	11V
Dynamic rise	5
Save job	

MMA setup parameters

Starting duration

Duration of the starting current for a hot or soft start

Unit	s
Setting range	0,1 - 5,0
Factory setting	1,5

To obtain optimum welding results, it will sometimes be necessary to adjust the hot or soft start function.

Advantages

- Improved ignition, even when using electrodes with poor ignition properties
 - Better fusion of the base metal in the start-up phase, meaning fewer cold-shut defects
 - Largely prevents slag inclusions
-

Voltage cut-off

Welding voltage limitation

Unit	V
Setting range	0 - 100
Factory setting	20

The arc length essentially depends on the welding voltage. To end the welding operation, it is usually necessary to make a pronounced lifting motion of the rod electrode away from the workpiece. With the 'Voltage cut-off' parameter, the welding voltage can be limited to a value that makes it possible to end the welding operation simply by lifting the rod electrode slightly.

NOTE! If, during welding, you often find that the welding operation is ended unintentionally, set the 'Voltage cut-off' parameter to a higher value.

Dynamic rise

The Dynamic rise parameter defines the rise in the welding current up to the set dynamic value at the moment of droplet transfer or in the event of a short-circuit.

Unit	-
Setting range	0 - 10
Factory setting	5

0 = Slow rise
10 = Fast rise

Save Job

Save the settings as a job

CEL electrode setup (Cel-elec.-Setup)

CEL setup

Cel-elec.-Setup	◀
Starting dur.	3,3s
Voltage cut-off	11V
Dynamic rise	1
Cel Char. slope	5

Cel setup parameters

Starting duration

Duration of the starting current for a hot start

Unit	s
Setting range	0,1 - 5,0
Factory setting	1,5

To obtain optimum welding results, it will sometimes be necessary to adjust the Hot start function.

Advantages

- Improved ignition, even when using electrodes with poor ignition properties
- Better fusion of the base metal in the start-up phase, meaning fewer cold-shut defects
- Largely prevents slag inclusions

Voltage cut-off

Welding voltage limitation

Unit	V
Setting range	0 - 100
Factory setting	20

The arc length essentially depends on the welding voltage. To end the welding operation, it is usually necessary to make a pronounced lifting motion of the rod electrode away from the workpiece. With the 'Voltage cut-off' parameter, the welding voltage can be limited to a value that makes it possible to end the welding operation simply by lifting the rod electrode slightly.

NOTE! If, during welding, you often find that the welding operation is ended unintentionally, set the 'Voltage cut-off' parameter to a higher value.

Dynamic rise

The Dynamic rise parameter defines the rise in the welding current up to the set dynamic value at the moment of droplet transfer or in the event of a short-circuit.

Unit	-
Setting range	0 - 10
Factory setting	5

0 = Slow rise
10 = Fast rise

CEL char. slope

CEL characteristic slope

Unit -

Setting range 0 - 5

Factory setting 5

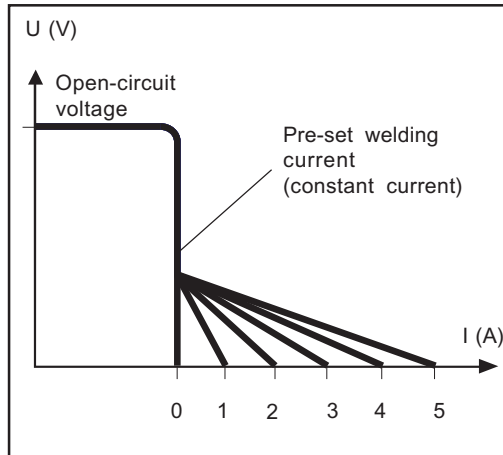
*CEL char. slope parameter setting*

The CEL char. slope parameter sets the gradient for the falling welding current characteristic. When welding cellulose electrodes, the characteristic slope is one of the most important criteria for the welding properties.

If the cellulose electrode tends to stick, adjust the CEL char. slope parameter to a higher value (flat characteristic).

Save jobSaves the settings as a job

Job setup

Job setup

The job setup is used to fine-tune and copy jobs. There are different job setups available to suit the process used in the saved jobs:

Job Setup	
Main current	175A
Dynamic	40
Starting current	150%
Starting dur.	3,3s

Job setup for MMA and CEL jobs

Job Setup	
Main current	175A
Starting current	70%
Gas post-flow	10s
Pulsing frequency	39Hz

Job setup for TIG jobs

Opening the job setup for a saved job



- 1 Press the Process button to select the job welding process::

JOB ●

The display shows the last selected job, e.g.:

Main current	
120 A	88V
Job 3	<SOFTSTAR>

The LED on the process symbol for the process of the selected job lights up.



- 2 Use the Left and Right buttons to select the job

Main current	
146 A	88V
Job 2	< CEL01 >



- 3 Press the Setup button

The display shows the job setup for the selected job, e.g.:

Job Setup	◀
Main current	175A
Dynamic	40
Starting current	150%
Starting dur.	3,3s

Copying a job



- 1 Press the Process button to select the job welding process:

JOB ●

The display shows the last selected job, e.g.:

Main current	
120 A	88V
Job 3	<SOFTSTAR>

The LED on the process symbol for the process of the selected job lights up.



- 2 Use the Left and Right buttons to select the job to be copied

Main current	
146 A	88V
Job 2	< CEL01 >



- 3 Press the Setup button

The display shows the job setup for the selected job, e.g.:

Job Setup	◀
Main current	175A
Dynamic	40
Starting current	150%
Starting dur.	3,3s



4 Turn the dial to select 'Save job':

Job Setup	◀
Voltage cut-off	0V
Dynamic rise	9
Cel Char. slope	4
Save job	



5 Press the dial

The first screen for saving a job is displayed:

Save job	◀
Job 1 < ABC >	
Job 2 < CEL01 >	
Job 3 < SOFTSTAR >	
Job 4 < TIG01 >	



6 Turn the dial to select the job number under which you want to save the job to be copied

Save job	◀
Job 2 < CEL01 >	
Job 3 < SOFTSTAR >	
Job 4 < TIG01 >	
Job 5 < >	

NOTE!

If you select an existing job, it will be overwritten without a prompt when you save.



7 Press the dial

The second screen for saving a job is displayed:

Save job	◀
Job 2 < _ >	
ABCDEF GHIJKLMNO	
PQRSTUVWXYZ0123	
456789- <input type="text"/> <input type="button" value="OK"/>	



8 Turn the dial to select the letters for the job name



9 Press the dial to accept the letters

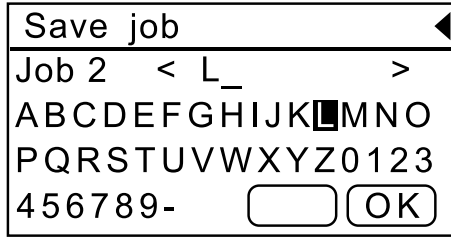

To change a letter:

- Use the Left and Right buttons to move the cursor to the required position
- Overwrite the letters



To delete a letter:

- Use the Left and Right buttons to move the cursor to the required position



Turn the dial to select the spacebar

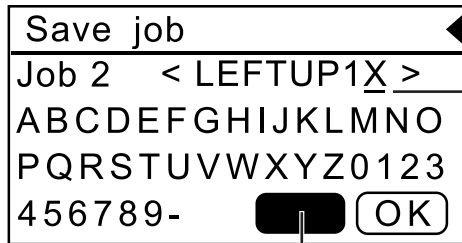

Cursor

Spacebar



Press the dial

The required letter is deleted:

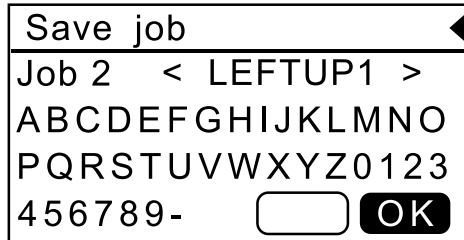

10 Turn the dial to select 'OK'



11 Press the dial

The display shows the copied job, e.g.:

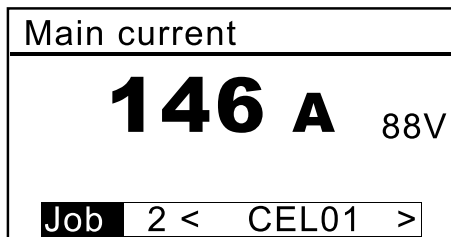

Job setup parameters for MMA and CEL jobs

Main current

Set target welding current

Unit	A
Setting range	10 - 250 for TP 2500 10 - 350 for TP 3500
Factory setting	-

Dynamic

To obtain optimum welding results, it will sometimes be necessary to adjust the arc-force dynamic.

Unit	-
Setting range	0 - 100
Factory setting	20

0 = Soft, low-spatter arc
100 = Harder, more stable arc

Working principle:

At the instant of droplet transfer or when a short-circuit occurs, there is a temporary rise in the current intensity. To obtain a stable arc, the welding current is increased temporarily. If the rod electrode threatens to sink into the weld pool, this measure prevents the weld pool solidifying, as well as preventing more prolonged short-circuiting of the arc. This largely prevents the rod electrode from "sticking".

Starting current

for hot or soft start

Unit	% (of main current)
Setting range	10 - 200
Factory setting	150

Startind duration

Duration of the starting current for a hot or soft start

Unit	s
Setting range	0,1 - 5,0
Factory setting	1,5

To obtain optimum welding results, it will sometimes be necessary to adjust the Hot start function.

Advantages

- Improved ignition, even when using electrodes with poor ignition properties
- Better fusion of the base metal in the start-up phase, meaning fewer cold-shut defects
- Largely prevents slag inclusions

Voltage cut-off

Welding voltage limitation

Unit	V
Setting range	0 - 100
Factory setting	20

The arc length essentially depends on the welding voltage. To end the welding operation, it is usually necessary to make a pronounced lifting motion of the rod electrode away from the workpiece. With the 'Voltage cut-off' parameter, the welding voltage can be limited to a value that makes it possible to end the welding operation simply by lifting the rod electrode slightly.

NOTE! If, during welding, you often find that the welding operation is ended unintentionally, set the 'Voltage cut-off' parameter to a higher value.

Dynamic rise

The Dynamic rise parameter defines the rise in the welding current up to the set dynamic value at the moment of droplet transfer or in the event of a short-circuit.

Unit	-
Setting range	0 - 10
Factory setting	5

0 = Slow rise

10 = Fast rise

CEL char. slope

CEL characteristic slope (for CEL jobs only)

Unit	-
Setting range	0 - 5
Factory setting	5

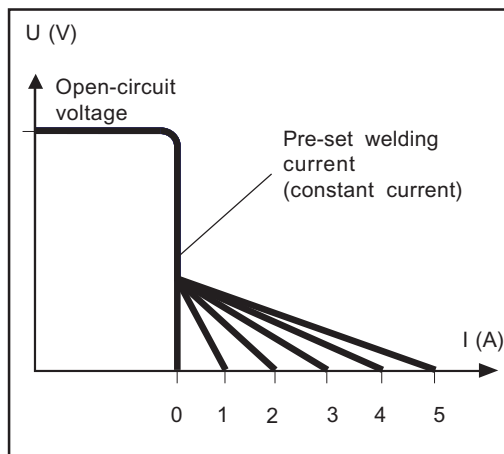

CEL char. slope parameter setting

The CEL char. slope parameter sets the gradient for the falling welding current characteristic. When welding cellulose electrodes, the characteristic slope is one of the most important criteria for the welding properties. If the cellulose electrode tends to stick, adjust the CEL char. slope parameter to a higher value (flat characteristic).

Save job

Saves the settings as a job

Job setup parameters for TIG jobs

Main current

Set target welding current

Unit	A
Setting range	10 - 250 for TP 2500 Comfort 10 - 350 for TP 3500 Comfort
Factory setting	-

Starting current

for TIG welding

Unit	% (of main current)
Setting range	10 - 100
Factory setting	15

Gas post flow

Gas post flow time

Unit	s
Setting range	0 - 25
Factory setting	10

Pulsing frequency

For setting the frequency of the pulsed arc.

The pulsed arc frequency is an important criterion for the TIG pulsed arc welding properties.

Unit	Hz
Setting range	Off / 1 - 60
Factory setting	1

Base current

Unit	% (of main current)
Setting range	10 - 100
Factory setting	50

TIG-Comfort Stop

The TIG-ComfortStop parameter determines how high the torch must be raised temporarily to trigger the TIG-Comfort Stop function. If the welding process is frequently stopped unintentionally, increase the value of the TIG-Comfort Stop parameter.

Unit	V
Setting range	Off / 1 - 20
Factory setting	Off

20 = Large increase in length of arc required

1 = Small increase in length of arc required

Off = TIG-Comfort Stop deactivated (factory setting)

End current

Unit	% (of main current)
Setting range	10 - 100
Factory setting	30

Save Job

Saves the settings as a job

TIG setup

TIG setup

WIG-Setup	◀
Gas post-flow	10s
Pulsing frequency	Off
Base current	50%
TIG-Comfort-Stop	Off

TIG setup parameters

Gas post-flow

Gas post-flow timet.

Unit	s
Setting range	0 - 25
Factory setting	10

Pulsing frequency

For setting the frequency of the pulsed arc.

The pulsed arc frequency is an important criterion for the TIG pulsed arc welding properties.

Unit	Hz
Setting range	Off / 1 - 60
Factory setting	1

Base current

Unit	% (of main current)
Setting range	0 - 100
Factory setting	50

TIG-Comfort Stop

The TIG-Comfort Stop parameter determines how high the torch must be raised temporarily to trigger the TIG-Comfort Stop function. If the welding process is frequently stopped unintentionally, increase the value of the TIG-Comfort Stop parameter.

Unit	V
Setting range	Off / 0 - 20
Factory setting	Off

20 = Large increase in length of arc required
1 = Small increase in length of arc required
Off = TIG-Comfort Stop deactivated (factory setting)

End current

Unit	% (of main current)
Setting range	0 - 100
Factory setting	30

Save job

Saves the settings as a job

The Service menu

General remarks The TP 2500 Comfort and TP 3500 Comfort power sources have a separate Service menu in which you can make the various basic settings.

Opening the Service menu You always open the Service menu in the same way, regardless of which process is currently selected.

 **1** Press and hold the Process button

 **2** Press the Setup button

The Service menu is displayed:

Service	◀
Language	GB
Op. Circ Voltage	90V
Anti-stick	On
Contrast	21

Selecting and setting parameters



1 Turn the dial to set a parameter:

Service	◀
Language	GB
Op. Circ. Voltage	90V
Anti-stick	On
Contrast	21



2 Press the dial to set the parameter

You can now change the parameter value

Service	◀
Language	GB
Op. Circ. Voltage	90V
Anti-stick	On
Contrast	21



3 Turn the dial to change the value of the parameter

Service	◀
Language	GB
Op. Circ. Voltage	12V
Anti-stick	On
Contrast	21



4 Press the dial to accept the set parameter value

Service	◀
Language	GB
Op. Circ. Voltage	12V
Anti-stick	On
Contrast	21

IMPORTANT! Set parameters remain in memory even if the mains plug is disconnected.

Exiting the Service menu



1 Exiting the Service menu

or



- Turn the dial to select the arrow symbol

Service	◀
Language	GB
Op. Circ. Voltage	90V
Anti-stick	On
Contrast	21



- Press the dial

The graphic shows the welding parameters.

Parameters in the Service menu

Language

for setting the display language

Unit	-
Setting range	D / GB / F / E
Factory setting	-

D = German
 GB = English
 F = French
 E = Spanish

Anti-stick

Unit	-
Setting range	On / Off
Factory setting	On

As the arc becomes shorter, the welding voltage may drop so far that the rod electrode will tend to “stick”. This may also cause “burn-out” of the rod electrode.

Electrode burn-out is prevented if the anti-stick function has been activated. If the rod electrode begins to stick, the power source immediately switches the welding current off. After the rod electrode has been detached from the workpiece, the welding operation can be continued without difficulty.

Contrast

For setting the display contrast

Unit	-
Setting range	10 - 44
Factory setting	20

Fan test

For testing the fan

Unit	-
Setting range	On / Off
Factory setting	Off

If the 'Fan test' parameter is set to 'On', the fan power source is running.

Sol.ValveTest

For testing the gas solenoid valve

Unit	-
Setting range	On / Off
Factory setting	Off

If the 'Sol.ValveTest' parameter is set to 'On', the gas solenoid valve picks up.

Job correction

For setting the correction options for job welding

Unit	%
Setting range	0 - 20
Factory setting	10

If you enter a value for the 'Job correction' parameter, you can increase or reduce the main current for a job by this value during job welding.

Easy Mode

Switches the simple display on or off

Unit	-
Setting range	On / Off
Factory setting	Off

The functions of and how to use the power source in Easy Mode are described in the 'Easy Mode' section

Inverse Display

Switches the inverse display on or off

Unit	-
Setting range	On / Off
Factory setting	Off

On = Inverse display active

Off = Normal Display

Examples:

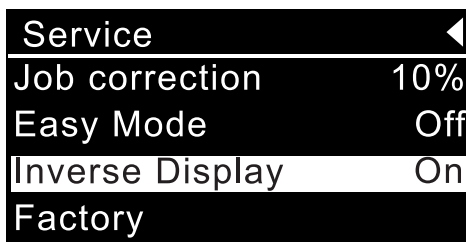
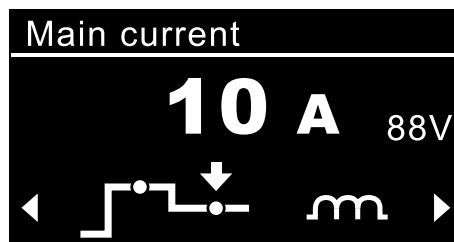
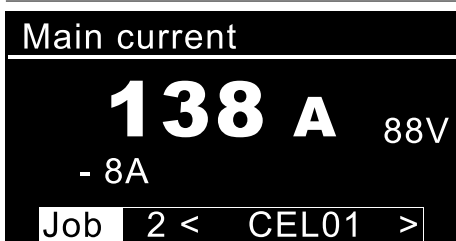
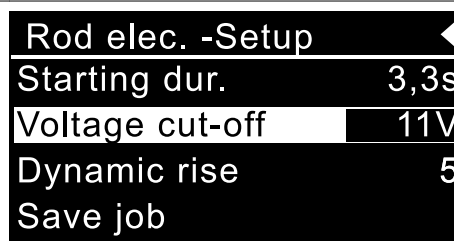
*Service menu inverse**Welding parameters inverse**Job welding inverse**MMA setup inverse*

Factory

Resets the power source

Unit	-
Setting range	No / Yes
Factory setting	-

Info

Displays unit data

Setting the language

- 1 Turn the dial to select 'Language'

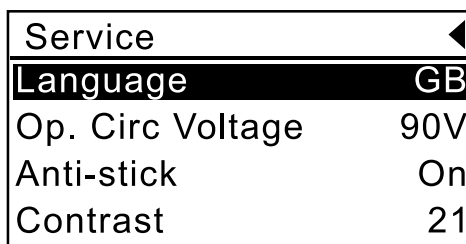

-  **2** Press the dial to set the language

You can now change the language:

Service	◀
Language	GB
Op. Circ. Voltage	90V
Anti-stick	On
Contrast	21

-  **3** Turn the dial to change the language.

Service	◀
Language	D
Op. Circ. Voltage	90V
Anti-stick	On
Contrast	21

-  **4** Press the dial to accept the language

The texts on the display appear in the selected language

Service	◀
Sprache	D
Leerlauf-Spannung	90V
Antistick	On
Kontrast	21

Resetting the power source factory settings

-  **1** Turn the dial to select 'Factory'

Service	◀
Easy Mode	Off
Inverse Display	Off
Factory	
Info	

-  **2** Press the dial

Service	◀
Easy Mode	Off
Inverse Display	Off
Factory	No
Info	



3 Turn the dial to select 'YES' and reset the power source

Service	◀
Easy Mode	Off
Inverse Display	Off
Factory	Yes
Info	



4 Press the dial

The power source is reset to the factory settings and the Service menu is displayed.

Service	◀
Easy Mode	Off
Inverse Display	Off
Factory	
Info	

Opening the Info screen



1 Turn the dial to select 'Info'

Service	◀
Easy Mode	Off
Inverse Display	Off
Factory	
Info	



2 Press the dial
The Info screen is displayed:

Info
Op. circ. hrs: 25 h 13 min
ArcBurning Time: 12 h 37 min
FPA25: 1 STTP2: 0

The Info screen contains the following data:

- Op. circ. hrs. (open-circuit hours)
- ArcBurningTime (total arc burning time)
- Version of PCB FPA25 and STTP2



- 3 Press the dial to exit the Info screen
The Service menu is displayed

Service	◀
Easy Mode	Off
Inverse Display	Off
Factory	
Info	

Voltage Reduction Device (VRD versions only)

General

A Voltage Reduction Device (VRD) is an optional safety device for reducing the voltage. As far as possible, VRD prevents output voltages at the current sockets that may pose a danger to persons.

Safety principle

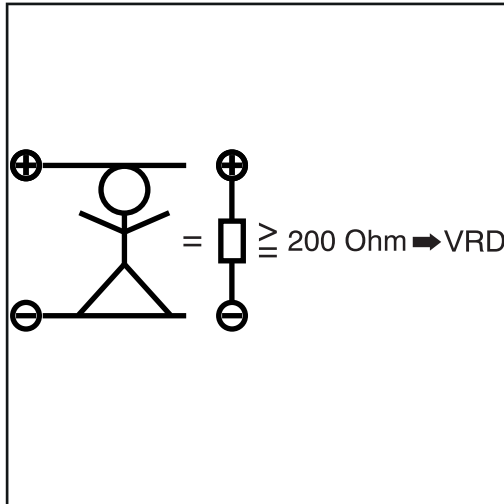

VRD is active

Welding circuit resistance is greater than the minimum human body resistance (greater than or equal to 200 Ohm):

- VRD is active
- Open circuit voltage is limited to 12 V (otherwise 90 V)
- There is no risk in unintentionally touching both welding sockets at the same time

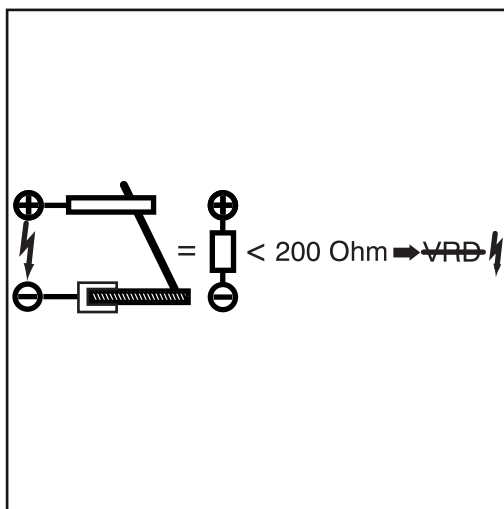

VRD is not active

Welding circuit resistance is less than the minimum human body resistance (less than 200 Ohm):

- VRD is inactive
- Output voltage not restricted in order to ensure sufficient welding power
- Example: Start of welding

IMPORTANT!

Within 0.3 seconds of the end of welding

- VRD is active again
- The output voltage is limited to 12 V again

VRD display

With VRD variants, the display indicates whether the VRD option is active or not:

VRD active

VRD inactive

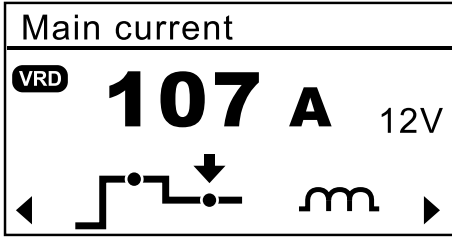

VRD active (VRD symbol on the display)

- The open-circuit voltage is limited to 12 V.

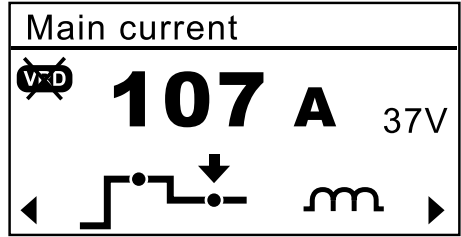

VRD inactive (VRD symbol crossed out on the display)

- No voltage limitation (e.g.: when welding) or
- VRD is defective

Troubleshooting

Safety



WARNING!

An electric shock can be fatal.

Before opening the device

- ▶ Turn the mains switch to the "O" position
 - ▶ Unplug the device from the mains
 - ▶ Ensure the device cannot be switched back on
 - ▶ Using a suitable measuring instrument, check to make sure that electrically charged components (e.g. capacitors) have been discharged
-



WARNING!

An inadequate ground conductor connection can cause serious injury or damage.

The housing screws provide a suitable ground conductor connection for earthing the housing.

- ▶ The housing screws must NOT be replaced by any other screws that do not provide a reliable ground conductor connection.
-

Fault diagnosis

No welding current

Mains switch on, indicator for selected mode does not illuminate

Cause: Break in the mains lead

Remedy: Check mains lead and mains voltage

No welding current

Device switched on, indicator for the selected welding process is lit

Cause: There is a break in the welding cable connections

Remedy: Check the plug connections

Cause: Poor or no earth

Remedy: Establish a connection to the workpiece

No welding current

Device switched on, indicator for the selected welding process is lit, error indicator lit

Cause: Duty cycle exceeded - device overloaded - fan running

Remedy: Keep within duty cycle

Cause: Thermostatic automatic circuit breaker has switched off the device

Remedy: Wait until the power source comes back on automatically at the end of the cooling phase (do not switch off the device - the fan will cool it down)

Cause: The fan in the power source is faulty

Remedy: Contact After-Sales Service

Cause: Insufficient cooling air intake

Remedy: Ensure adequate air supply

Cause: Air filter is dirty

Remedy: clean air filter

Cause: Power module error

Remedy: Turn off the device, then turn it on again
If the error occurs frequently, contact After-Sales Service

Poor ignition properties during MMA welding

Cause: Incorrect welding process selected

Remedy: Select the appropriate welding process

In some cases, arc breaks during welding

Cause: TIG Comfort Stop parameter value set too low for selected TIG welding process

Remedy: Adjust the TIG Comfort Stop parameter to a higher value in the Setup menu

Cause: Electrode (e.g. grooved electrode) voltage too high

Remedy: If possible, use an alternative electrode or a power source with more welding power

Cause: Incorrect welding process selected

Remedy: Select "TIG welding" or "TIG pulsed arc welding" process

Rod electrode tends to stick

Cause: Value of arc-force dynamic parameter (MMA welding) set too low

Remedy: Increase value of arc-force dynamic parameter

Mains fuse or automatic circuit breaker trips

Cause: Mains fuse underrated/incorrect circuit breaker

Remedy: Fuse mains correctly (see Technical data)

Cause: Mains fuse trips in open circuit

Remedy: Contact After-Sales Service

LED for set process is flashing

Cause: Single-phase operation with a welding current greater than 140A

Remedy: Select a welding current less than 140A and continue welding

Cause: Phase failure

Remedy: Check the mains lead

Poor weld properties

(severe spattering)

Cause: Incorrect electrode polarity

Remedy: Reverse electrode polarity (refer to manufacturer's instructions)

Cause: Poor ground earth connection

Remedy: Fasten earthing clamps directly to workpiece

Cause: Setup parameters not ideal for selected welding process

Remedy: Select best setting in Setup menu for selected process

TIG welding

Tungsten electrode melting - tungsten inclusions in base material during the ignition phase

Cause: Incorrect tungsten electrode polarity

Remedy: Connect TIG welding torch to negative pole

Cause: Incorrect (or no) shielding gas

Remedy: Use inert shielding gas (argon)

Cause: Incorrect welding process selected

Remedy: Select TIG welding or TIG pulsed arc welding process (TP 2500/3500 TIG)

Service codes



Open circuit (Leerlauf)

Cause: Output voltage is greater than 110 V

Remedy: Switch machine off and on again; if error keeps recurring, have machine serviced



Mains undervoltage or overvoltage (OVUV)

Cause: The mains voltage is outside the tolerance range

Remedy: Check mains voltage, switch machine off and on again; if error keeps occurring, have machine serviced



Earth current (with earth current watchdog option only)

Cause: Current flowing via machine earth

Remedy: Check ground (earth) connection to workpiece, switch machine off and on again; if error keeps occurring, have machine serviced



Short-circuit after switching on the machine (KS)

Cause: Short circuit between electrode holder and grounding (earthing) terminal

Remedy: Rectify short circuit, switch machine off and on again; if error keeps occurring, have machine serviced

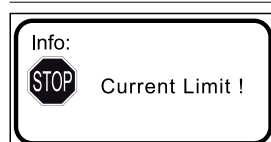

Current Limit

Cause: internal error

Remedy: Switch machine off and on again; if error keeps recurring, have machine serviced

**ILZ**

Cause: internal error

Remedy: Switch machine off and on again; if error keeps recurring, have machine serviced

**Asymmetrie (Asym. Betr.)**

Cause: Internal error

Remedy: Switch machine off and on again; if error keeps recurring, have machine serviced

**Asymmetrie (Asym. Init.) (on switching on)**

Cause: Internal error

Remedy: Switch machine off and on again; if error keeps recurring, have machine serviced

**Primary current (IP)**

Cause: Internal error

Remedy: Switch machine off and on again; if error keeps recurring, have machine serviced

**Current transformer polarity (I prim. pol.)**

Cause: The primary current transformer was fitted incorrectly

Remedy: Fit the primary current transformer with the correct polarity

**Phase**

Cause: Phase failure

Remedy: Check incoming mains cable, switch machine off and on again; if error keeps occurring, have the machine serviced



Temperature (Temp.)

Cause: Overtemperature

Remedy: Wait for the machine to come back on automatically shortly after the end of the cooling phase; if it does not, have the machine serviced

Care, maintenance and disposal

General

Under normal operating conditions, the power source requires only a minimum of care and maintenance. However, some important points must be noted to ensure that the welding system remains in a usable condition for many years.



WARNING!

An electric shock can be fatal.

Before opening the device

- ▶ Move the mains switch to the "O" position
 - ▶ Unplug the device from the mains
 - ▶ Put up an easy-to-understand warning sign to stop anybody inadvertently reconnecting it
 - ▶ Using a suitable measuring instrument, check to make sure that electrically charged components (e.g. capacitors) have been discharged
-

At every start-up

- Check mains plug, mains cable, welding torch, interconnecting hosepack and grounding (earthing) connection for damage
- Check that the device has an all-round clearance of 0.5 m (1ft. 8in.) to ensure that cooling air can flow and escape unhindered

NOTE!

Air inlets and outlets must never be covered, not even partially.

Every 2 months

- clean air filter
-

Every 6 months

- Dismantle device side panels and clean inside of device with dry reduced compressed air

NOTE!

Risk of damage to electronic components.

Do not bring the air nozzle too close to electronic components.

- If a lot of dust has accumulated, clean the cooling-air ducts
-

Disposal

Dispose of in accordance with the applicable national and local regulations.

Average consumption values during welding

Average wire electrode consumption during MIG/MAG welding

Average wire electrode consumption at a wire speed of 5 m/min			
	1.0 mm wire electrode diameter	1.2 mm wire electrode diameter	1.6 mm wire electrode diameter
Steel wire electrode	1.8 kg/h	2.7 kg/h	4.7 kg/h
Aluminium wire electrode	0.6 kg/h	0.9 kg/h	1.6 kg/h
CrNi wire electrode	1.9 kg/h	2.8 kg/h	4.8 kg/h

Average wire electrode consumption at a wire speed of 10 m/min			
	1.0 mm wire electrode diameter	1.2 mm wire electrode diameter	1.6 mm wire electrode diameter
Steel wire electrode	3.7 kg/h	5.3 kg/h	9.5 kg/h
Aluminium wire electrode	1.3 kg/h	1.8 kg/h	3.2 kg/h
CrNi wire electrode	3.8 kg/h	5.4 kg/h	9.6 kg/h

Average shielding gas consumption during MIG/MAG welding

Wire electrode diameter	1.0 mm	1.2 mm	1.6 mm	2.0 mm	2 x 1.2 mm (TWIN)
Average consumption	10 l/min	12 l/min	16 l/min	20 l/min	24 l/min

Average shielding gas consumption during TIG welding

Gas nozzle size	4	5	6	7	8	10
Average consumption	6 l/min	8 l/min	10 l/min	12 l/min	12 l/min	15 l/min

Technical data

Safety

NOTE!

An inadequately dimensioned electrical installation can cause serious damage.
The mains lead and its fuse protection must be rated accordingly. The technical data shown on the rating plate applies.

Generator-powered operation

The TP 2500 Comfort and TP 3500 Comfort power sources are totally generator-compatible, provided that the maximum apparent power delivered by the generator is at least 14 kVA for the TP 2500 Comfort and 22 kVA for the TP 3500 Comfort.

TP 2500 Comfort

Mains voltage (U_1)	3 x	380 V	400 V	460 V
Max. effective primary current ($I_{1\text{eff}}$)		10.5 A	10.1 A	8.6 A
Max. primary current ($I_{1\text{max}}$)		17.7 A	17.0 A	14.6 A
Mains fuse protection				16 A slow-blow
Mains voltage tolerance				-10 % /+ 10 %
Mains frequency				50 / 60 Hz
Cos Phi (1)				0,99
Recommended earth-leakage circuit breaker				B
Welding current range (I_2)				
Rod electrode				15 - 250 A
TIG				15 - 250 A
Welding current at	10 min / 40 °C (104 °F)	40 %	60 %	100 %
		250 A	200 A	175 A
Output voltage range according to standard characteristic (U_2)				
Rod electrode				20,6 - 30 A
TIG				10,6 - 20 A
Open circuit voltage (U_0 peak, U_0 r.m.s)				88 V
Open circuit voltage VRD				12 V
Degree of protection				IP 23
Type of cooling				AF
Overvoltage category				III
Pollution level according to IEC60664				3
Safety symbols				S, CE
Dimensions l x w x h				430 x 180 x 320 mm 16.9 x 7.1 x 12.6 in.
Weight				12,5 kg 27.5 lb.

Max. shielding gas pressure	5 bar 72.5 psi.
Max. noise emission (LWA)	74 dB (A)
Idle state power consumption at 400 V	23.7 W
Power source efficiency at 250 A / 30 V	87 %

**TP 2500 Comfort
MVm**

Mains voltage (U ₁)	3 x	200 V	230 V
Max. effective primary current (I _{1eff})		16.2 A	15.9 A
Max. primary current (I _{1max})		27.4 A	26.8 A
Mains fuse protection		20 A slow-blow	
Mains voltage (U ₁)	3 x	380 V	400 V 460 V
Max. effective primary current (I _{1eff})		10.5 A	10.1 A 8.6 A
Max. primary current (I _{1max})		17.7 A	17.0 A 14.6 A
Mains fuse protection		16 A slow-blow	
Mains voltage tolerance		-10 % /+ 10 %	
Mains frequency		50 / 60 Hz	
Cos Phi (1)		0,99	
Recommended earth-leakage circuit breaker		B	
Welding current range (I ₂)			
Rod electrode		15 - 250 A	
TIG		15 - 250 A	
Welding current at	10 min / 40 °C (104 °F)	40 %	60 % 100 %
		250 A	200 A 175 A
Output voltage range according to standard characteristic (U ₂)			
Rod electrode		20,6 - 30 V	
TIG		10,6 - 20 V	
Open circuit voltage (U ₀ peak, U ₀ r.m.s)		88 V	
Open circuit voltage VRD		12 V	
Degree of protection		IP 23	
Type of cooling		AF	
Overvoltage category		III	
Pollution level according to IEC60664		3	
Safety symbols		S, CE, CSA	
Dimensions l x w x h		430 x 180 x 320 mm 16.9 x 7.1 x 12.6 in.	
Weight		12,5 kg 27.5 lb.	
Max. shielding gas pressure		5 bar	

	72.5 psi.
Max. noise emission (LWA)	74 dB (A)
Idle state power consumption at 400 V	23.7 W
Idle state power consumption at 250 A / 30 V	87 %

TP 3500 Comfort

Mains voltage (U ₁)	3 x	380 V	400 V	460 V
Max. effective primary current (I _{1eff})		17.5 A	16.8 A	15.1 A
Max. primary current (I _{1max})		29.5 A	28.3 A	25.4 A
Mains fuse protection				25 A slow-blow
Mains voltage tolerance				-10 % /+ 10 %
Mains frequency				50 / 60 Hz
Cos Phi (1)				0,99
Recommended earth-leakage circuit breaker				B
Welding current range (I ₂)				
Rod electrode				10 - 350 A
TIG				10 - 350 A
Welding current at	10 min / 40 °C (104 °F)	40 %	60 %	100 %
		350 A	280 A	230 A
Output voltage range according to standard characteristic (U ₂)				
Rod electrode				20.4 - 34 V
TIG				10.4 - 24 V
Open circuit voltage (U ₀ peak, U ₀ r.m.s)				88 V
Open circuit voltage VRD				12 V
Degree of protection				IP 23
Type of cooling				AF
Overvoltage category				III
Pollution level according to IEC60664				3
Safety symbols				S, CE
Dimensions l x w x h				500 x 190 x 380 mm 19.68 x 7.48 x 14.96 in.
Weight				20,1 kg 44.3 lb.
Max. shielding gas pressure (TIG)				5 bar 72.5 psi.
Max. noise emission (LWA)				70 dB (A)
Idle state power consumption at 400 V				26 W
Power source efficiency at 350 A / 34 V				86 %

**TP 3500 Comfort
MVm**

Mains voltage (U_1)	3 x	200 V	230 V
Max. effective primary current ($I_{1\text{eff}}$)		27 A	24.7 A
Max. primary current ($I_{1\text{max}}$)		45.6 A	41.8 A
Mains fuse protection		35 A slow-blow	
Mains voltage (U_1)	3 x	380 V	400 V 460 V
Max. effective primary current ($I_{1\text{eff}}$)		17.5 A	16.8 A 15.1 A
Max. primary current ($I_{1\text{max}}$)		29.5 A	28.3 A 25.4 A
Mains fuse protection		25 A slow-blow	
Mains voltage tolerance		-10 % /+ 10 %	
Mains frequency		50 / 60 Hz	
Cos Phi (1)		0,99	
Recommended earth-leakage circuit breaker		B	
Welding current range (I_2)			
Rod electrode		10 - 350 A	
TIG		10 - 350 A	
Welding current at	10 min / 40 °C (104 °F)	40 %	60 % 100 %
		350 A	280 A 230 A
Output voltage range according to standard characteristic (U_2)			
Rod electrode		20.4 - 34 V	
TIG		10.4 - 24 V	
Open circuit voltage (U_0 peak, U_0 r.m.s)		88 V	
Open circuit voltage VRD		12 V	
Degree of protection		IP 23	
Type of cooling		AF	
Overvoltage category		III	
Pollution level according to IEC60664		3	
Safety symbols		S, CE, CSA	
Dimensions l x w x h		500 x 190 x 380 mm 19.68 x 7.48 x 14.96 in.	
Weight		20,1 kg 44.3 lb.	
Max. shielding gas pressure (TIG)		5 bar 72.5 psi.	
Max. noise emission (LWA)		70 dB (A)	
Idle state power consumption at 400 V		26 W	
Power source efficiency at 350 A / 34 V		86 %	

Overview with critical raw materials, year of production of the device

Overview with critical raw materials:

An overview of which critical raw materials are contained in this device can be found at the following Internet address.

www.fronius.com/en/about-fronius/sustainability.

To calculate the year of production of the device:

- Each device is provided with a serial number
- The serial number consists of 8 digits - for example 28020099
- The first two digits give the number from which the year of production of the device can be calculated
- This figure minus 11 gives the year of production
 - For example: Serial number = 28020065, calculation of the year of production = 28 - 11 = 17, year of production = 2017

FRONIUS INTERNATIONAL GMBH

Froniusstraße 1
A-4643 Pettenbach
AUSTRIA
contact@fronius.com
www.fronius.com

Under **www.fronius.com/contact** you will find the addresses
of all Fronius Sales & Service Partners and locations



Find your
spareparts online



spareparts.fronius.com